

# CritiCool<sup>®</sup>

## User Manual



Conformity according to the Council Directive 93/42/EEC



**Manufactured for:**



Belmont Medical Technologies  
780 Boston Road  
Billerica, MA 01821 USA  
Technical Service  
885-397-4547 (USA)  
+1-978-663-0212 (WORLDWIDE)  
[www.BelmontMedTech.com](http://www.BelmontMedTech.com)

**European Representative:**

**EC REP** Emergo Europe BV  
Prinsessegracht 20  
2514 AP The Hague  
The Netherlands

**Switzerland Authorized Representative:**

**CH REP** Medenvoy Switzerland  
Gotthardstrasse 28  
6302 ZUG  
Switzerland

Copyright by Belmont Medical Technologies. All RIGHTS RESERVED  
Registered trademarks are the intellectual property of their respective holders.

## ***Use of Manual***

The purpose of this manual is to help medical personnel trained on the usage of this system understand and operate the system. It is important that you read this manual and familiarize yourself thoroughly with its contents before you attempt to operate the system. If you do not understand any part of this manual, or if anything is unclear or ambiguous in any way, please contact your Belmont Medical Technologies representative.

The CritiCool® system described in this manual has been designed to meet international safety and performance standards. Only trained medical personnel may operate the system, and these operators must first have a full understanding of the proper operation of the system.

The information provided in this manual is not intended to replace regular medical training procedures.

This manual should always accompany the system. All qualified personnel operating the system should know the location of the manual. For additional copies of this manual, please contact your Belmont Medical Technologies representative.

## ***Training***

Belmont Medical Technologies or its authorized distributor will provide training for the system user according to the intended use of the system.

It is the responsibility of the hospital management to ensure that only users trained to use the equipment safely operate the system.

## ***Operator Profile***

Connections and system settings should be performed by a clinical expert in thermoregulation.

## ***Important Notice***

No part of this manual may be reproduced or copied in any form by any graphic, electronic or mechanical means - including photocopying, scanning, typing or information retrieval systems - without advanced written permission from Belmont Medical Technologies.

## ***Disclaimer***

**NOTE:** Instructions regarding the reusable temperature probes are NOT applicable for the US market.

Belmont Medical Technologies is not responsible for any consequential or incidental damages or expenses of any kind, impairment of or damage to other goods caused by the following:

- a. Installed, operated, maintained contrary to Belmont Medical Technologies instructions, notes or warnings under this manual.
- b. Ignoring any of the warnings, precautions and safety measures indicated in this manual.
- c. Replacement, repair or alteration not performed by Belmont Medical Technologies or authorized personnel.
- d. The use of accessories and other parts or equipment made by other manufacturers, whether or not warranted by such manufacturers, which have been attached or connected to the system after installation, unless such accessories and other parts have been supplied and attached or installed by Belmont Medical Technologies.
- e. Using the system in a contrary manner than indicated in this manual or using the system for any purpose other than indicated in the manual.

---

---

# TABLE OF CONTENTS

---

---

CHAPTER 1: SAFETY PRECAUTIONS .....	11
Definitions.....	11
Intended Use .....	11
Contraindications .....	11
Warnings .....	11
Precautions.....	12
EMC Safety .....	13
Improper Use.....	13
Labels.....	14
Label Symbols .....	15
CHAPTER 2: SYSTEM DESCRIPTION.....	17
General Description .....	17
CritiCool® System .....	18
CritiCool® Device .....	18
External Features .....	19
Front View .....	19
Side View.....	20
Rear Panel.....	21
CureWrap® .....	22
Description and Intended Use.....	22
Wrap Material .....	22
Usage Duration.....	22
Selected Wrap Design .....	24
Accessories .....	24
Temperature Probes.....	24
Detachable Electric Power Cable & Plug .....	27
Connecting Tubes for Wrap .....	27
Male Connector for Draining Water Tank.....	27
Spare Water Filter.....	27
Handle .....	27
CliniLogger™ (Optional) .....	27
Temperature Splitter (Optional).....	28
System Specifications.....	28
CritiCool® Technical Specifications .....	29
CliniLogger™ Technical Specifications .....	31
CHAPTER 3: INSTALLATION .....	32
Pre-installation Requirements .....	32
Space and Environmental Requirements.....	32
Electrical Requirements.....	32
Equipment List.....	32
Unpacking and Inspection.....	33

Unpacking CritiCool from the Box .....	33
Assembling the Handle .....	34
Moving the Unit.....	35
Preparation: .....	35
Locking and Unlocking the Trolley Wheels.....	35
Packing CritiCool for Shipment .....	35
CHAPTER 4: OPERATING INSTRUCTIONS .....	36
General.....	36
CritiCool Functions .....	37
Controls, Functions, Indicators and Connections .....	38
Main Power Switch .....	38
CritiCool® Screen Controls.....	38
QCC— Quick Coupling Connectors .....	39
Temperature Probe Sockets .....	40
Patient Thermoregulation – Step by Step Operation .....	40
Operating the System .....	40
Inserting and Attaching Temperature probes .....	42
Connecting the Water Hoses (Tubes) to CritiCool.....	43
Activating the System .....	44
Wrapping the Patient .....	45
The Control Panel.....	45
Patient Mode .....	46
The Main Menu.....	50
Standby Mode .....	51
Mode Select.....	52
Temperature Graph .....	54
Settings .....	55
Services .....	58
Modes of Operation .....	60
Normothermia Management .....	67
Replacing the Wrap .....	70
Operation Panel Messages and Alerts.....	71
Safety Messages and Alarms .....	72
Clinical Messages and Alarms .....	73
Technical Messages .....	75
Informative Messages.....	78
TTM Mode Messages .....	79
Controlled Rewarming Mode Messages .....	82
CHAPTER 5: ORDERING INFORMATION.....	84
Equipment and Accessories.....	84
Available Wraps.....	84
Available Accessories.....	85
CHAPTER 6: MAINTENANCE.....	87
Introduction.....	87
Service Information.....	87
Routine Maintenance.....	88

Routine Maintenance Overview .....	89
Before Each Use.....	89
Before Storage .....	90
<i>Thermal Disinfection (Self-Cleaning)</i> .....	91
System Check Service.....	91
Filter Replacement.....	93
CHAPTER 7: TROUBLESHOOTING .....	94
General.....	94
Troubleshooting Guide.....	94
CHAPTER 8: CLINILOGGER™ INSTALLATION AND OPERATING INSTRUCTIONS .....	103
Overview and Installation .....	103
Introduction.....	103
Using the CliniLogger™ Application .....	103
The CliniLogger™ Software .....	103
Installing the Software.....	103
Using the CliniLogger™ Viewer Application .....	107
Downloading Data .....	107
Viewing Downloaded Data.....	108
CliniLogger™ Viewing Panel.....	110
Converting to Excel.....	117
Ending a Viewing Session .....	118
APPENDIX A: .....	119
Belmont Medical Technologies CUSTOMER SERVICE REPRESENTATIVE.....	119
APPENDIX B: RF SEPARATION.....	120
APPENDIX C: WASTE ELECTRICAL & ELECTRONIC EQUIPMENT (WEEE) .....	121

---



---

# LIST OF FIGURES

---



---

Figure 1: Label Placement for the CritiCool® Device. ....	14
Figure 2: Front View.....	19
Figure 3: Side View.....	20
Figure 4: Rear View. ....	21
Figure 5: Measurements. ....	23
Figure 6: Disposable Temperature Probe Connections.....	26
Figure 7: Handle Assembly.....	34
Figure 8: Self-Test Screen. ....	40
Figure 9: Mode Select Upon Startup.....	44
Figure 10: Main Screen.....	44
Figure 11: The Control Panel. ....	45
Figure 12: Main Menu. ....	50
Figure 13: Standby Mode.....	51
Figure 14: Select Mode Panel.....	52
Figure 15: Temperature Graph.....	54
Figure 16: Settings Screen 1.....	55
Figure 17: Settings Screen 2.....	56
Figure 18: Settings Screen 3.....	56
Figure 19: Settings Screen 4.....	57
Figure 20: Start Emptying Panel. ....	59
Figure 21: Emptying Water - Performing Panel.....	59
Figure 22: Core Readout Too Low Message.....	61
Figure 23: Thermoregulation is Continuing Message.....	62
Figure 24: Select Mode Controlled Rewarming.....	63
Figure 25: Switching to Rewarming Message. ....	64
Figure 26: Controlled Rewarming Mode.....	64
Figure 27: Temperature Regulation Paused Message.....	65
Figure 28: Target Temperature Setting Panel.....	66
Figure 29: Normothermia Mode.....	68
Figure 30: Out of Normothermia Message.....	69
Figure 31: Adjustable Alarm Limits.....	71
Figure 32: Low Core Temperature Message.....	79
Figure 33: Temperature Regulation Paused Message.....	80
Figure 34: Thermoregulation is Continuing Message.....	81
Figure 35: Core Readout too Low Message.....	82
Figure 36: Thermoregulation is Continuing Message.....	83
Figure 37: Selecting System Check.....	92
Figure 38: System Check in Progress.....	92
Figure 39: CliniLogger™ Initialization.....	104
Figure 40: CliniLogger™ Installation.....	104
Figure 41: Start Installation.....	105
Figure 42: Installation Progress.....	105
Figure 43: Installation Complete.....	106
Figure 44: CliniLogger™ Application Window.....	107
Figure 45: CliniLogger™ Window.....	108
Figure 46: Choose CliniLogger™ File Window.....	109
Figure 47: Complete Message.....	109



Figure 48: CliniLogger™ Viewing Panel..... 110  
Figure 49: Graphic Display Area. .... 111  
Figure 50: Example: Functional Status Area. .... 112  
Figure 51: Example: Modes and Errors Area. .... 112  
Figure 52: Example of Modes and Error Area. .... 116  
Figure 53: Section of Excel Table. .... 117  
Figure 54: Section of Graphic Chart..... 118

---

---

# LIST OF TABLES

---

---

Table 1: Key to Label Symbols .....	15
Table 2: CureWrap® .....	24
Table 3: Disposable Temperature Probes .....	27
Table 4: CritiCool® screen keys .....	38
Table 5: Clinical Messages .....	73
Table 6: Clinical Messages .....	74
Table 7: Technical Messages and Alarms .....	75
Table 8: Technical Messages and Alarms .....	76
Table 9: Technical Messages and Alarms .....	77
Table 10: Wrap Information .....	84
Table 11: CritiCool Infant Reusable Accessory Kit (PN# 200-00320) .....	85
Table 12: CritiCool Adult Reusable Accessory Kit (PN# 200-00300) .....	85
Table 13: CritiCool Infant Disposable Accessory Kit (PN# 200-00330) .....	86
Table 14: CritiCool Adult Disposable Accessory Kit (PN# 200-00310) .....	86
Table 15: Accessories .....	86
Table 16: Inspection and Maintenance Schedule .....	88
Table 17: CritiCool® System Malfunction (no message) Troubleshooting Guide .....	95
Table 18: Water Tank Overfilling .....	96
Table 19: CritiCool® System Messages Troubleshooting Guide .....	97
Table 20: CritiCool® System Messages Troubleshooting Guide .....	98
Table 21: CritiCool® System Messages Troubleshooting Guide .....	99
Table 22: CritiCool® System Messages Troubleshooting Guide .....	100
Table 23: CritiCool® System Messages Troubleshooting Guide .....	101
Table 24: Zoom Tool Buttons .....	114
Table 25: Mode Codes .....	116
Table 26: Separation Distances in meters .....	120

# CHAPTER 1: SAFETY PRECAUTIONS

## *Definitions*

**WARNING!!!** Indicates a condition that may endanger the patient or the system operator

**CAUTION!** Indicates a condition that may damage the equipment

**NOTE:** Indicates ways in which the system's operation can be made more efficient.

## *Intended Use*

CritiCool® is a thermal regulating system, indicated for monitoring and controlling patient temperature.

## *Contraindications*

CritiCool® should not be used on patients with open wounds.

## *Warnings*

1. The physician must be notified if the patient's temperature does not respond properly, does not reach the prescribed temperature, or if there is any change in the prescribed temperature range. Failure to inform the physician may result in injury to the patient.
2. The misuse of the temperature regulation equipment can be potentially harmful to the patient.
3. Use only sterile water or 0.22 µm filtered water. Sterile water is recommended.
4. Do not plug wet probes into the sockets of the CritiCool® device.
5. The user should verify that no fluids are present at the skin/wrap interface during the procedure. Failure to do so can cause lesions on the patient's skin.
6. Following the procedure, a pattern resembling the wrap may appear for a short period of time on the patient's skin.
7. Pressure sores may appear or develop when soft tissue is compressed between a bony prominence and external surface. The use of the CritiCool® system does not prevent this from happening.

8. Routine care should be taken during long thermoregulation procedures to prevent pressure sores.
9. Do not lift or move the patient by means of the wrap. This may cause tearing and water leakage.
10. Prevent any thermal isolation, such as a pillow or other items, between the Wrap and the patient's body.
11. Do not apply heating/cooling to lower extremities during aortic cross clamping. Thermal injury may occur if heating/cooling is applied to ischemic limbs.
12. Wraps cannot be placed over transdermal patches.
13. Wraps should not come in contact with open wounds.
14. CureWrap® should not be in direct contact with open, widespread skin lesions such as burns or dermatitis.
15. Caution should be taken when using CureWrap® with patients that have underlying skin conditions.
16. Do not touch the ribbon cable behind the display and the patient simultaneously.
17. Patients thermoregulated with CritiCool® should be closely monitored at all times.

### ***Precautions***

1. Follow the warning notes listed in the various sections of this manual.
2. Only trained personnel, familiar with all system operating procedures and certified only by Belmont Medical Technologies or authorized agents of Belmont Medical Technologies are allowed to use the CritiCool® system.
3. If moisture or leaks are discovered in the connecting hose and/or Wrap, turn off the CritiCool® device, disconnect the power cable from its power source, and correct the problem before proceeding.
4. If the system sounds an alarm and/or presents a display other than the standard Belmont Medical Technologies display, the operator should proceed according to the display message and/or the troubleshooting instructions ( see "Troubleshooting Guide").
5. Avoid folds in the Wrap—these may obstruct water flow.
6. Do not block the CritiCool® system ventilation grilles. Air must be able to flow freely in and out in order to keep the system cool.
7. Do not use de-ionized water or water created through reverse osmosis because it may promote corrosion of the metal components of the system.
8. When X-ray imaging is performed on a patient wearing a wrap, shadows from the wrap may appear on the X-ray film. Connecting water hoses should not be connected to the patient during imaging as they contain metal.

9. Avoid inserting any sharp object between the patient and the Wrap.
10. Read all manufacturers' instructions associated with the temperature probes or temperature probe adapters supplied by Belmont Medical Technologies.
11. Accessories from one system should not be moved or switched out with those from another system to avoid cross-contamination.

### ***EMC Safety***

For safe use of the CritiCool<sup>®</sup>, it is required to keep the CritiCool<sup>®</sup> at a safe distance from systems emitting radio frequency (RF) energy.

Refer to Appendix B for recommended separation distances between the CritiCool<sup>®</sup> and RF source.

***CAUTION!***

*Power interruptions shorter than 10 minutes return the machine to the mode that was operating before the interruption with a 3-beep alarm.*

***IMPORTANT!*** *Make sure to read the messages to ensure correct reactivation of the machine.*

### ***Improper Use***

Improper use of the CritiCool<sup>®</sup> system can lead to skin lesions, electrical hazards, and severe changes in body temperature.

***CAUTION!*** *U.S. Federal law restricts this system to sale by or on the order of a physician.*

# Labels

## CritiCool® System Labels

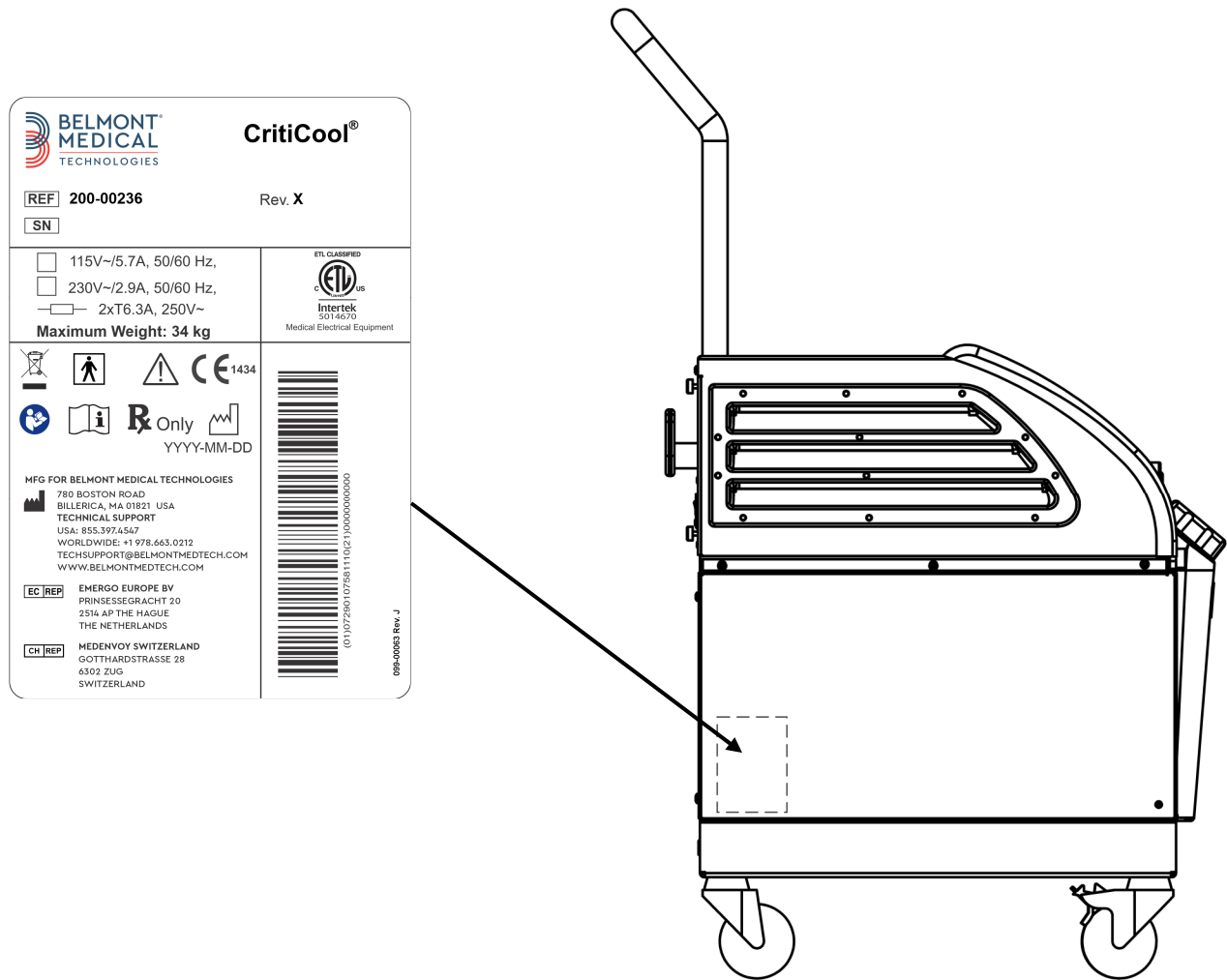



















Figure 1: Label Placement for the CritiCool® Device.

## Label Symbols

**Table 1: Key to Label Symbols**

Description	Symbol
CE mark of conformity indicates that the product has received the European approval for MDD 93/42/EEC.	
AC Voltage	
Fuse	
The serial number for this product	
Catalogue part number	
European Authorized Representative	
Switzerland Authorized Representative	
Caution – refer to user manual	
Type BF equipment	
Recycle for WEEE	
Date of manufacture	

Name of manufacturer	
Country of manufacturer	
Do not push	
Refer to instruction manual / booklet	
Restricts the sale and use of this instrument to qualified medical personnel only.	<b>R<sub>x</sub> Only</b>
Unique Device Identifier	<b>UDI</b>
Instructions for Use	
Does not contain natural rubber latex	
Medical Device	<b>MD</b>
Do Not Reuse	



## CHAPTER 2: SYSTEM DESCRIPTION

### *General Description*

A growing number of cases require a solution for controlling patient temperature in various hospital settings. Therapeutic hypothermia, Targeted Temperature Management (TTM) or simply controlling normothermia is beneficial and sometimes vital.

The CritiCool® system controls and maintains temperature in an effective and precise manner. The desired temperature is preset by the physician with a possible range of target temperatures from Hypothermia to Normothermia.

The system is composed of two elements, the CritiCool® device, and the CureWrap®. The CritiCool® device functions as a control unit and a cooling/heating pump, which circulates water. The control unit constantly monitors the patient's core temperature through specific probes and using its on-board body temperature control algorithm at 133 millisecond intervals, delivers the optimum water temperature to reach the desired set point temperature. The cooling/heating pump brings the water to the required temperature and the pump circulates it through the specially designed flexible and single piece CureWrap®.

The CureWrap® is designed to be in close contact with a large area of the body, thus allowing optimization of energy transfer.

**WARNING!!!**     *The Belmont Medical Technologies wrap is proprietary to Belmont Medical Technologies and this is the only wrap authorized to be used with the CritiCool® system. Use of any other wrap with the system may harm the patient.*

## CritiCool® System

The CritiCool® system consists of the following elements:

- CritiCool® device
- CureWrap®
- Accessories

## CritiCool® Device

The CritiCool® device has a microprocessor that controls the water temperature flowing into the wrap worn by the patient.

The water temperature is controlled and maintained to the desired set point by measuring the actual patient temperature (core and surface) and adjusting the temperature of the wrap accordingly.

Timed pauses of flow during clinical operation regulate the water pressure and water flow in CureWrap. During the initial phase of regulation, the flow cycle is 12 minutes ON (water flows through the wrap) and 1 minute OFF (water recirculates within CritiCool®; no flow through the wrap) in both TTM and Normothermia modes.

In a steady state (when the core temperature is within the set point range), the cycle is 12 minutes ON and 12 minutes OFF.

If the difference between the patient's core temperature and the set point temperature exceeds 0.3°C at any time during a timed pause, water will return to the wrap to adjust the patient's temperature.

The CritiCool® device is equipped with a handle for easy transport.

## External Features

### Front View

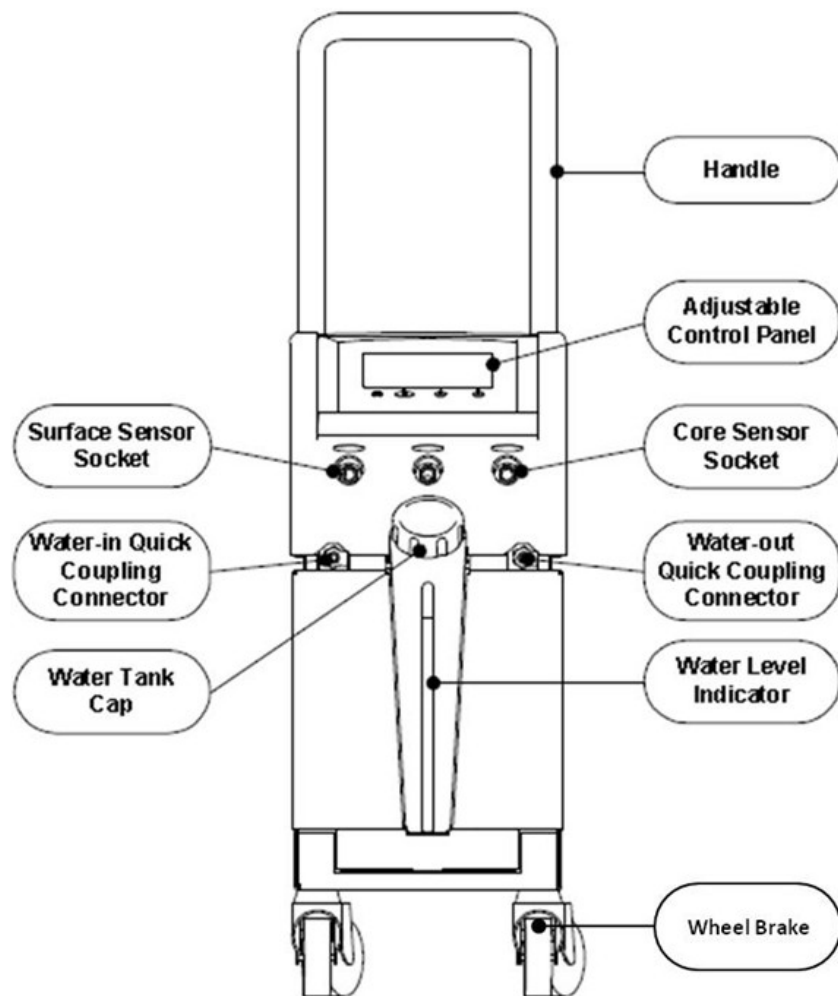

Figure 2: Front View.

Side View

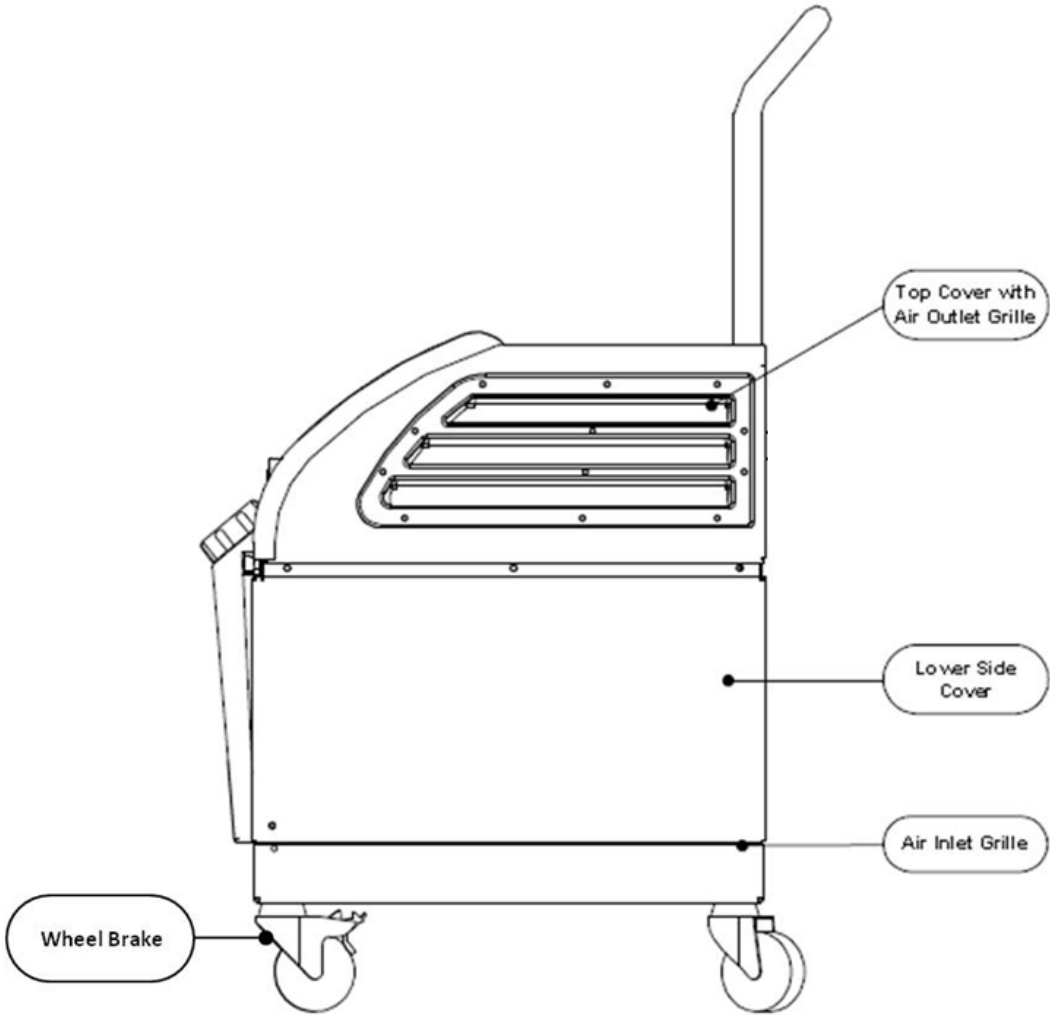
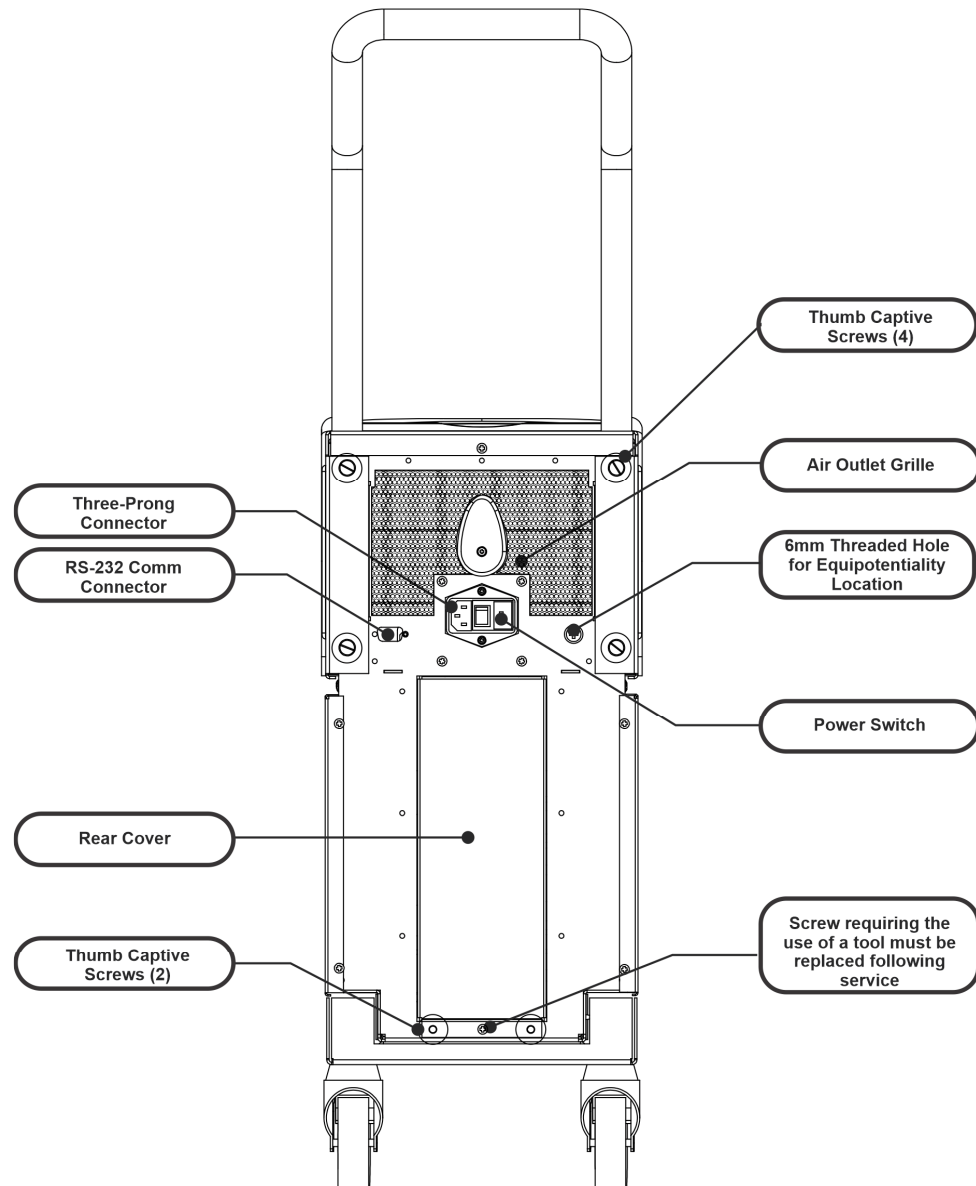

Figure 3: Side View.

## Rear Panel



**Figure 4: Rear View.**

## ***CureWrap***<sup>®</sup>

### **Description and Intended Use**

The wrap is a one-piece wrap with a one-inflow and one or two return water connections that circulate water in the wrap channels.

The Wrap is:

- Disposable
- Biocompatible
- Antistatic
- Adjustable
- Not made with natural rubber latex

Each section of the Wrap is separately wrapped around the appropriate area of the patient (e.g., chest, arms.)

### **Wrap Material**

- **Patient side:** Non-Woven Polypropylene
- **Exterior:** Brushed Loop Fabric

### **Usage Duration**

- The wrap is durable for up to 120 hours. Replace the wrap if it becomes soiled.

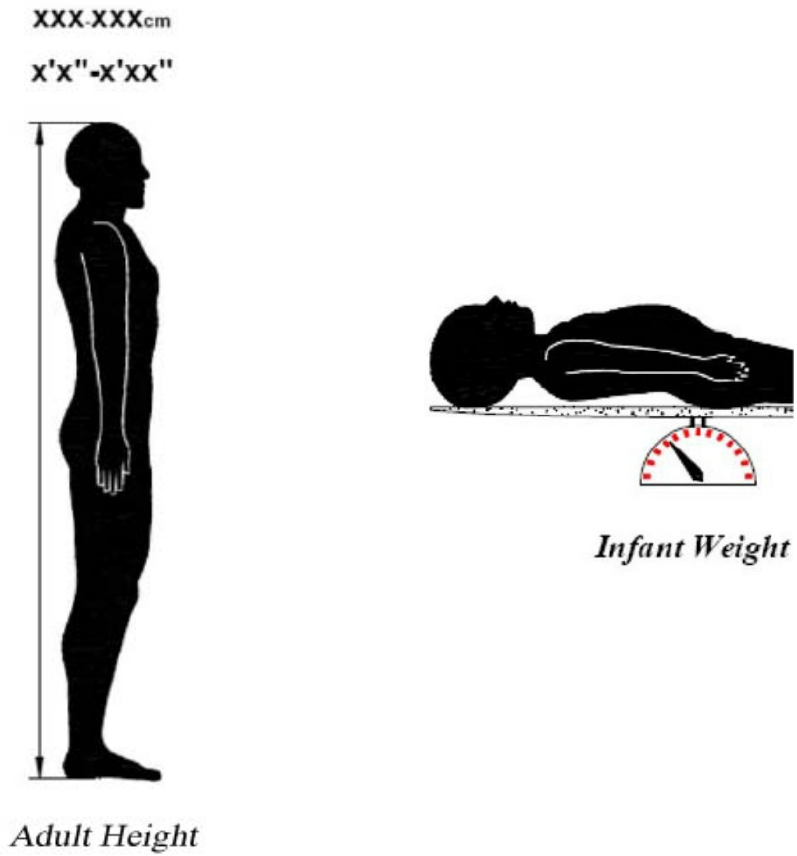

**Figure 5: Measurements.**

## Selected Wrap Design

The wraps are available in a range of sizes and are based on patient size and weight.

**Table 2: CureWrap®**

	Type	P/N	Number of wraps per Box	Patient Size/Weight	Wrap Height/Width (m)
CureWrap Single Size Pediatric Boxes	Infant	508-03518	Box (X8; single size)	2.5-4 Kg	0.659 / 0.448
		508-03521	Box (X8; single size)	4-7 Kg	0.698 / 0.602
CureWrap Assorted Pediatric Boxes	Small	PED-SM008	Box (X8; multi-size)	2.5- 4 Kg (X4), 4-7 Kg (X4)	0.659 / 0.448 0.698 / 0.602
	Medium	PED-MD008	Box (X8; multi-size)	7-11 Kg (X4), 79-91 cm (X4)	0.981 / 0.628 1.118 / 0.740
	Large	PED-LA008	Box (X8; multi-size)	91-104 cm (X4), 104-122 cm (X4)	1.225 / 0.841 1.390 / 1.054
	X-Large	PED-XL008	Box (X8; multi-size)	122-135 cm (X4), Over 135 cm (X4)	1.582 / 1.1193 2.030 / 1.354
CureWrap Single Size Adult Boxes	Adult	508-03500	Box (X8; single size)	Over 135 cm	2.030 / 1.354

## Accessories

The following accessories are available for use in conjunction with the CritiCool® system.

## Temperature Probes

### Intended Use

Core temperature probes are used to measure the patient's core temperature.

Disposable temperature probes are recommended.

Surface temperature probes are used to measure the patient's skin temperature, in a location not covered by the wrap.

**NOTE:** Reusable temperature probes are not available for sale in the USA and select markets.

**CAUTION!** Before use, check the packaging and expiration date of the temperature probes. If the package is not completely sealed or the temperature probes are past the expiration date, avoid using the temperature probes.



## Reusable Temperature Probes

**IMPORTANT!** *All instructions regarding the reusable temperature probes are NOT applicable for the USA market and select markets.*

There are three color-coded reusable temperature probes: Adult Core 12 FR (gray), Surface (green), and Infant Core 10 FR (gray), and Surface (green). Both core and surface probes must be plugged into the CritiCool® system. The core temperature probes must be inserted, and the surface temperature probe must be attached to the patient for the system to function properly.

**CAUTION!** *The cleaning, disinfection and the sterilization of the reusable temperature probes are done in accordance with the manufacturer's directions. Refer to the manufacturer's user guide for details of applicable usage.*

### 1.1 12 FR Adult Core Temperature Probe:

The core temperature probe (gray 12FR) measures core body temperature when inserted into the patient's body. The plug of the probe cable is inserted into the gray core socket at the front of the CritiCool® device.

### 1.2 10 FR Infant Core Temperature Probe:

The core temperature probe (gray 10FR) measures core body temperature when inserted into the patient's body. The plug of the probe cable is inserted into the gray core socket at the front of the CritiCool® device.

### 1.3 Surface Temperature Probe:

The surface temperature probe (green) measures body surface temperature when attached to the patient's skin. The plug of the probe cable is inserted into the green surface socket at the front of the CritiCool® device.

**NOTE:** The response time for temperature feedback to the CritiCool for all temperature probes once plugged in and attached to the patient is less than 60 seconds.

## Disposable Temperature Probes

Disposable temperature probes are attached to two color-coded adaptors: gray (Core) and green (Surface). Both adaptors are reusable. For the system to function properly, the core temperature probe must be inserted into the patient and the surface temperature probe must be attached to the patient's skin.

### **CAUTION!**

Before use, please check the packaging and expiration date of the disposable temperature probes. If the package seal is not intact or the probes have expired, do not use. Review the instructions for use and contraindications for the probes prior to use.

### 1.4 Disposable Surface Temperature Probe:

The disposable surface temperature probe is attached to the reusable surface adapter (green). The adapter is plugged into the green surface socket at the front of the CritiCool® device. The temperature probe is attached to the patient's skin and measures surface body temperature.

### 1.5 Disposable Core Temperature Probe:

The disposable core temperature probe is attached to the reusable core adapter (gray). The adapter is plugged into the gray core socket at the front of the CritiCool® device. The temperature probe is inserted into the patient (esophagus/rectum) and measures core body temperature.

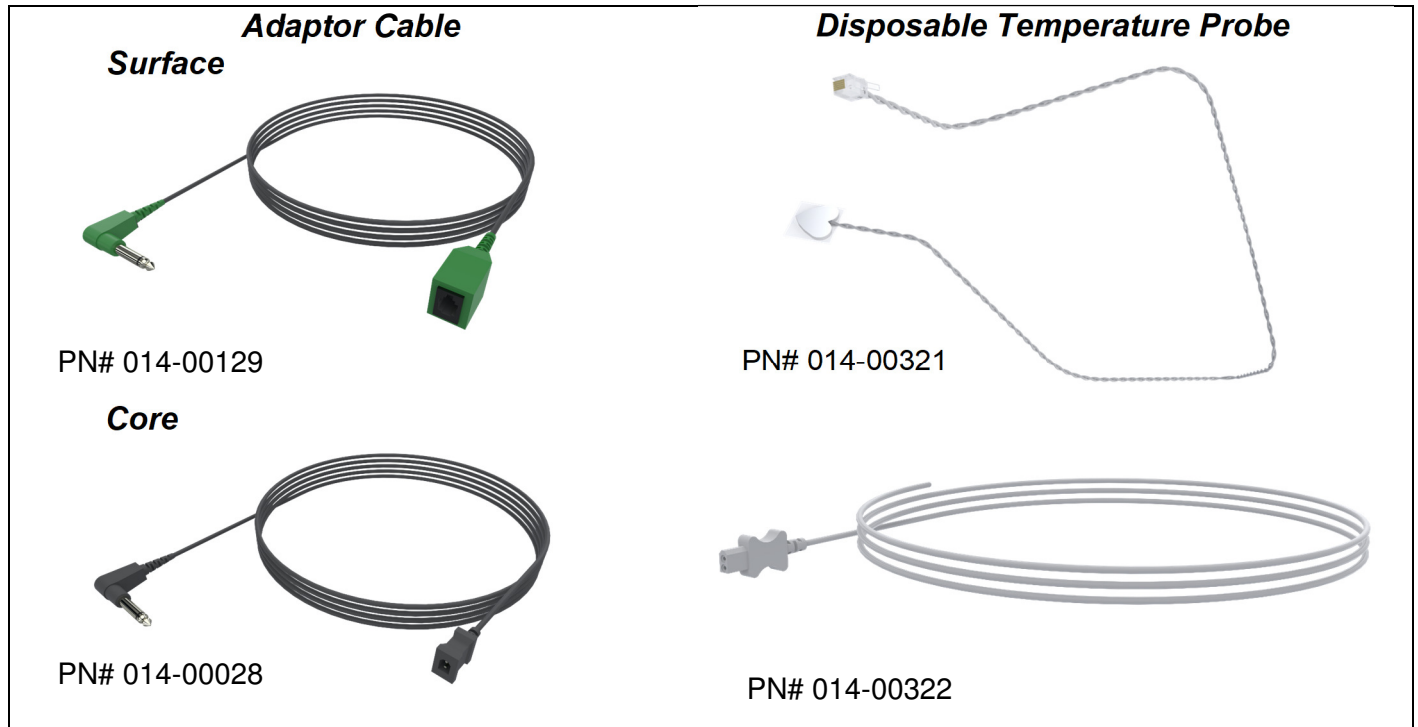

**Figure 6: Disposable Temperature Probe Connections.**

Table 3: Disposable Temperature Probes

<i>Part number</i>	<i>Description</i>
<b>Surface</b>	
014-00129	Adaptor Cable for Disposable Surface Temperature Probes RJ, Green
014-00321	Disposable Surface Temperature Probes RJ (20/pack)
<b>Core</b>	
014-00028	Adaptor Cable for Disposable Core Temperature Probes, Gray
014-00322	Disposable Core Temperature Probes (20/pack)

## Detachable Electric Power Cable & Plug

Use the power cord to power the system.

## Connecting Tubes for Wrap

Two flexible 2.58 m long connecting tubes connect the wrap with the CritiCool® device to enable the flow of water between them.

The tubes are supplied as a paired unit with two or three male Quick Coupling Connectors for the CritiCool® device and with two or three female Quick Coupling Connectors for the Wrap.

## Male Connector for Draining Water Tank

The male connector is attached to the connecting tubes and is used to drain the water tank. It connects to the outflow hose of the Quick Coupling Connector of the Connecting Tubes.

## Spare Water Filter

The spare water filter is used by a trained biomedical technician for annual filter replacement.

## Handle

A handle is shipped with every system and should be attached to the device to facilitate intra-hospital transport.

## CliniLogger™ (Optional)

CliniLogger™ is used to collect the system parameters during the thermoregulation procedure. It connects to the serial port on the rear of the device either vertically with the grey right angle adapter attached at the bottom, or horizontally, with the adapter removed.

## Temperature Splitter (Optional)

The Temperature Splitter is compatible for the CritiCool® system using the YSI 400 Series temperature probes. The Temperature Splitter measures the patient's temperature using a single sensor in the patient and displays the temperature on both the CritiCool® screen and an additional system, such as a monitor, eliminating the need to use two separate sensors. See the diagram.

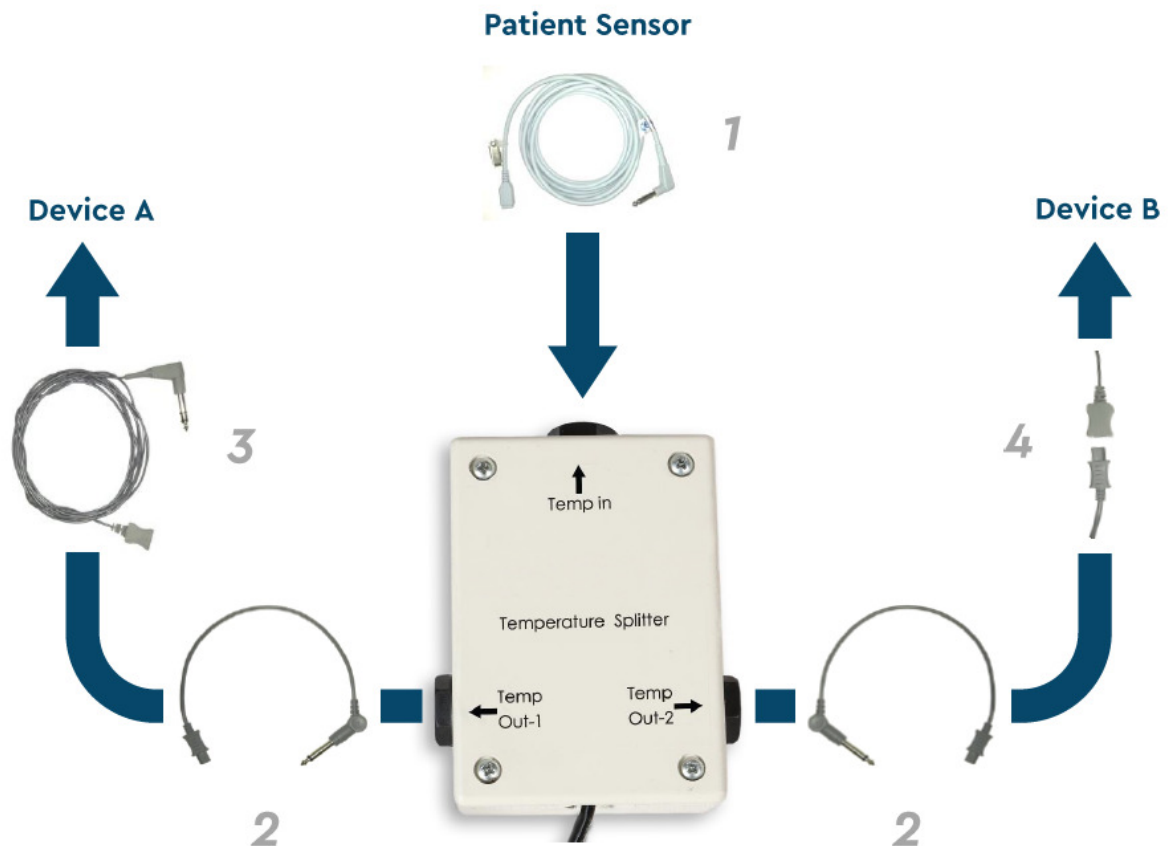

## System Specifications

See the following page for system specifications.

## CritiCool® Technical Specifications

<b>CritiCool®</b>	
<p>CritiCool®, one of Belmont Medical Technologies' temperature regulating systems, induces, maintains and reverses hypothermia in an effective and precise manner. The desired patient temperature is preset by the physician with a possible range of target temperature from mild hypothermia to normothermia.</p> <p>The system is composed of two elements, the CritiCool device and the CureWrap® garment. The CritiCool® device functions as a control unit, constantly monitoring the patient's core temperature every 133 milliseconds, and as a cooling/heating device which brings the circulating water to the required temperature by using its on-board body temperature control algorithm. The CureWrap® is a flexible 3D single-piece garment through which water circulates. It is designed to be in close contact with a large area of the body to optimize energy transfer.</p>	
<b>Control Unit</b>	
<b>Physical Dimensions</b>	Mobile Unit with 4 wheels and 2 brakes 260 mm W x 625 mm D x 940 mm H (10.23" W x 24.6" D x 37"H)
<b>Net Weight</b>	34 kg / 75 lb
<b>Environmental Operating Conditions</b>	
<b>Temperature</b>	5°C to 40°C (41-104°F)
<b>Humidity</b>	10 to 93%, non-condensing
<b>Note:</b>	Do not use in an atmosphere with flammable anesthetic mixtures.
<b>Environmental Storage Conditions</b>	
<b>Temperature</b>	-15°C to +68°C (5-154°F)
<b>Humidity</b>	10 to 93%, non-condensing
<b>Hardware</b>	
<b>Electricity Input Power</b>	230/115 VAC (Switchable) with isolation transformer 50/60 Hz 100 VAC with isolation transformer 50/60 Hz
<b>Maximum Power Consumption</b>	690 Watts 230 VAC 2.9A 115 VAC 5.7A 100 VAC 6.6A
<b>Heat Exchangers</b>	Peltier Technology - Thermoelectric Coolers (TECs)
<b>External Ports</b>	(1) Isolated Serial Port
<b>LCD Display Size</b>	144.8mm / 5.7" color display
<b>LCD Display Resolution</b>	320x240
<b>User Interface</b>	Multicapacitive Touch Screen 5 soft push buttons
<b>System Sensors</b>	3 Internal Temperature Sensors: 1) Water In, 2) Water Out, and 3) Thermostat 2 Pressure Sensors
<b>Water</b>	
<b>Water Type:</b>	Sterile or 0.22 µ filtered water
<b>Tank Capacity:</b>	6 liters (1.6 gallon)
<b>Pump Rate:</b>	1.2 L/minute
<b>Water Temperature Accuracy:</b>	±0.3°C
<b>Water Temperature (Outflow) Range:</b>	13-40.8°C (55.4-105.4°F)

Patient Temperature		
<b>Patient Temperature Channels</b>	2 channels: 1) Core and 2) Surface	
<b>Patient Temperature Probe Accuracy</b>	±0.3°C	
Software		
<b>Modes of Operation</b>	TTM (Targeted Temperature Management) Controlled Rewarming Normothermia Standby (No thermoregulation; monitoring only)	
Patient Set Point Temperature		
<b>Target Temperature Range</b>	30-40°C (adjustable in 0.1°C increments)	
<b>TTM Mode Default Set Points</b>	Neonatal Mode: 33.5°C Adult Mode: 33.0°C	
<b>Controlled Rewarming Default Target Temp</b>	36.5°C	
<b>Controlled Rewarming Default Rate Range</b>	0.05°C – 0.5°C per hour	
<b>Manual Rewarming Rate</b>	Adjustable in 0.1°C increments	
<b>Adjustable Alarm Limits</b>	High Patient Temperature Low Patient Temperature High Water Temperature	
<b>Displayed Information</b>	Mode of Operation Care Time System Status and alarms Patient Set Point Temperature Patient Target Temperature Patient Core Temperature Patient Surface Temperature Temperature Graph Technician mode and display	
Languages		
<ul style="list-style-type: none"> <li>• English (EN)</li> <li>• Czech (CS)</li> <li>• Danish (DA)</li> <li>• Dutch (NL)</li> <li>• Finnish (FI)</li> </ul>	<ul style="list-style-type: none"> <li>• French (FR)</li> <li>• German (DE)</li> <li>• Italian (IT)</li> <li>• Norwegian (NO)</li> <li>• Polish (PL)</li> </ul>	<ul style="list-style-type: none"> <li>• Portuguese (PT)</li> <li>• Russian (RU)</li> <li>• Spanish (ES)</li> <li>• Swedish (SV)</li> <li>• Turkish (TR)</li> </ul>
CureWrap®		
<b>Range of Sizes</b>	44 cm – 200 cm	
<b>Duration of Use</b>	up to 120 hours unless soiled	
Wrap Storage		
<b>Storage Span</b>	5 years	
<b>Temperature Conditions</b>	10°C to 27°C	
<b>Humidity Conditions</b>	10-90%	
Wrap Transport		
<b>Temperature Conditions</b>	-20°C to 60°C	
<b>Humidity Conditions</b>	20-95%	

## CliniLogger™ Technical Specifications

### CliniLogger™

CliniLogger™ is an optional accessory for CritiCool® / CritiCool® MINI / Allon® Thermoregulation Systems. It is used to collect the system parameters during the thermoregulation procedure.

CliniLogger™ must be connected to the serial port on the rear of the device to collect data. It can be connected vertically with the grey right angle adapter attached at the bottom (as shown at the right), or horizontally once the adapter has been removed.

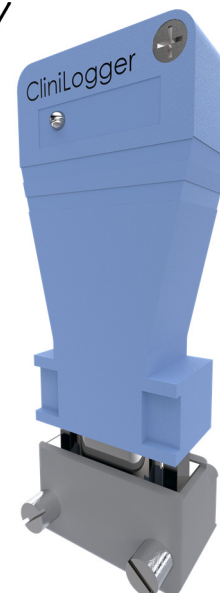

#### Hardware

<b>Connector</b>	DB9 connector for serial interfacing to CritiCool® or general PC
<b>Size</b>	35 x 65 mm
<b>Controller</b>	MSP4301611 Micro controller with the following features: <ul style="list-style-type: none"> <li>– Built in Flash and RAM</li> <li>– Built in UART &amp; SPI</li> <li>– Built in DMA controller</li> </ul>
<b>Memory</b>	Flash memory capacity: 2 MB
<b>Power Requirement</b>	5 Volt DC supplied from the CritiCool® or general PC <ul style="list-style-type: none"> <li>– &lt;20 mA</li> <li>– &lt;100 mW</li> </ul>
<b>LED</b>	Bicolor (Green / Red)
<b>Data Storage Rate</b>	Every 1 minute into flash memory
<b>Serial Communication</b>	RS232: <ul style="list-style-type: none"> <li>– 19200 bps to CritiCool®</li> <li>– 115200 bps to PC</li> </ul>
<b>Data Collected</b>	Temperature: Set Point, Core, Surface Time Water Circulation ON/OFF Water Heat/Cool Mode of Operation Errors
<b>CliniViewer Software</b>	PC Application

## CHAPTER 3: INSTALLATION

### *Pre-installation Requirements*

#### Space and Environmental Requirements

The CritiCool® system is supplied on a trolley as a mobile unit for user convenience. It must be located no less than 5 cm (2") from other objects to avoid the impairing of ventilation to the CritiCool® system.

The following dimensions should be considered when placing the CritiCool® system:

260 mm W x 625 mm D x 940 mm H / (10.23"W x 24.6"D x 37"H)

#### Electrical Requirements

230/115VAC 500W or 100 VAC

**WARNING!!!** To avoid the risk of electric shock, this equipment must only be connected to a mains supply with protective earth (PE).

**CAUTION!** Verify that the voltage switch is set for the local voltage.

#### Equipment List

The CritiCool® system includes the following:

- CritiCool® control unit
- Handle
- Power cord
- Spare filter
- User manual
- Quick reference guide
- Accessories Kit for CritiCool® – one of the following (See Table 11 through Table 14):
  - 200-00300 Accessory Kit Adult with Reusable Temperature Probes
  - 200-00310 Accessory Kit Adult for Disposable Temperature Probes
  - 200-00320 Accessory Kit Infant with Reusable Temperature Probes
  - 200-00330 Accessory Kit Infant for Disposable Temperature Probes



## Unpacking and Inspection

The CritiCool® system has undergone full quality assurance testing before shipment and should be operational upon delivery.

The unit should be unpacked, installed and tested only by Belmont Medical Technologies authorized personnel. No attempt should be made by the purchaser to unpack or assemble the unit alone.

**NOTE:** Report any container damage prior to opening the container, or any unit damage prior to unpacking, installation, or testing to your Belmont Medical Technologies distributor.

### Unpacking CritiCool from the Box

Follow the instructions shown here to properly unpack CritiCool.

Upon arrival, check the SHOCKWATCH® and TIP-N-TELL® indicators.

If either has been activated, immediately open the package and check for external damage. If the device has been damaged, photograph the damage and immediately notify the shipping carrier and/or Belmont Medical Technologies at [techservice@belmontmedtech.com](mailto:techservice@belmontmedtech.com), being sure to provide all relevant information, including evidence of the damage.

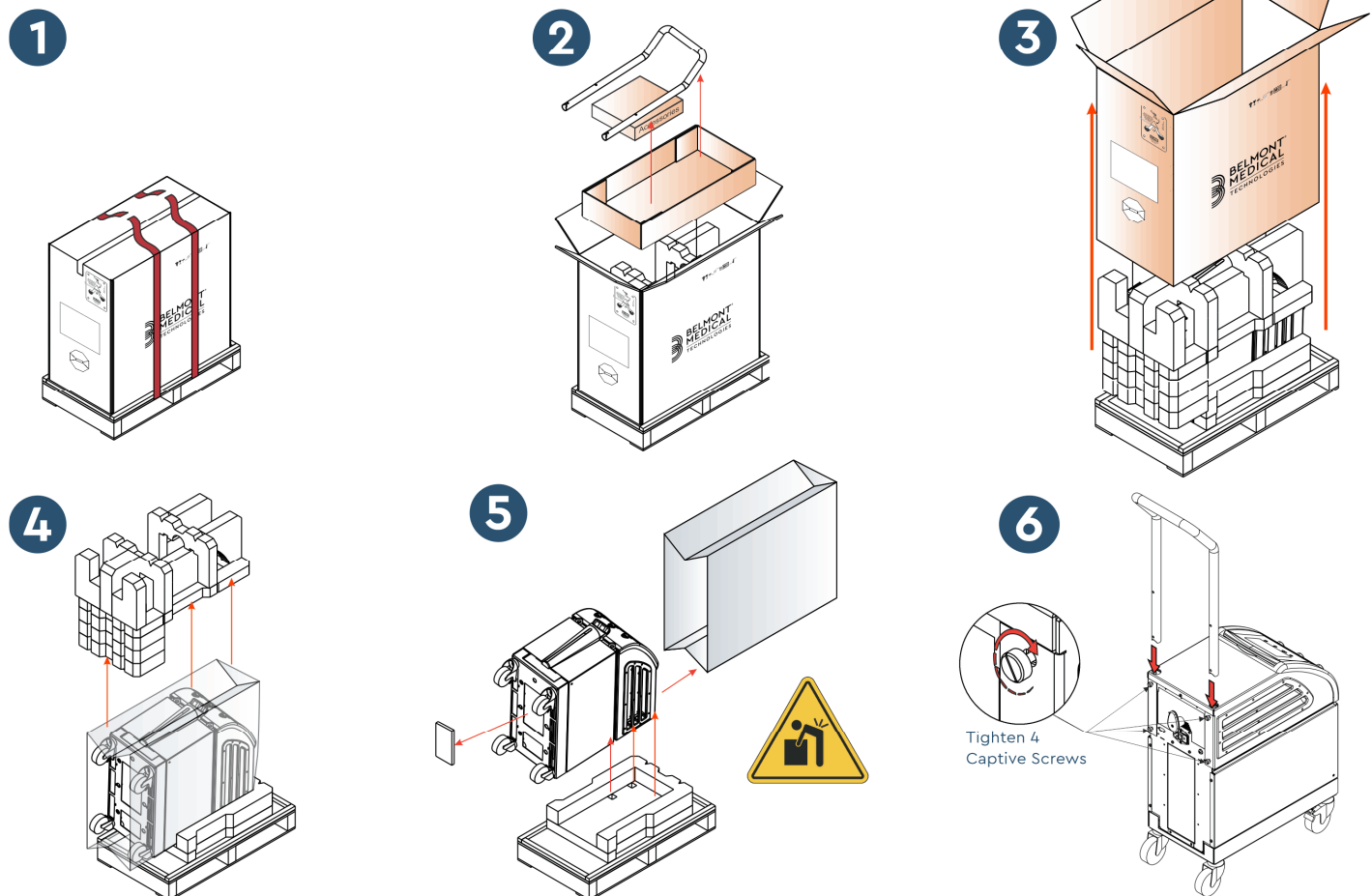

## Assembling the Handle

### *To assemble the handle:*

1. Release the four thumb screws by hand.
2. Slide the two ends of the handle into the holes in the top cover (pay attention to the direction of the curve in the handle) until the handle is inserted all the way in (See Figure 7).
3. Press in and screw the four thumb screws by hand (do not use force when tightening) to secure the handle and the top cover.

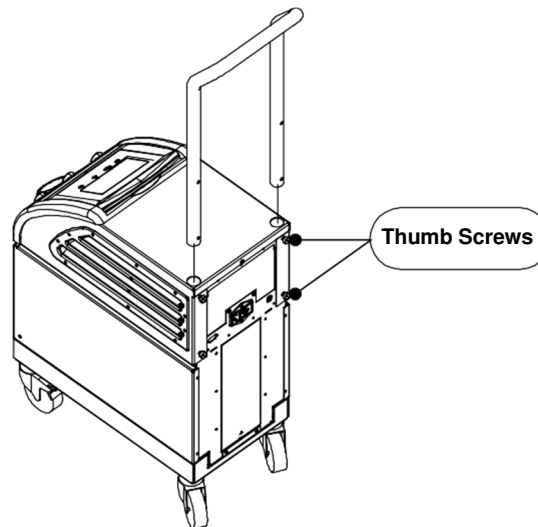

**Figure 7: Handle Assembly.**

## Moving the Unit

### Preparation:

Before moving the unit:

1. Ensure that the CritiCool® system is off by pressing the ON / OFF switch.
2. Ensure that all electrical connections are disconnected.

### Locking and Unlocking the Trolley Wheels

The CritiCool® device trolley has four wheels. The front wheels are fitted with a brake. The brake lever is located over the wheel. To lock the wheels, firmly press the lever. To release the wheels, lift the lever.

When the unit is stationary, the brakes must be in the locked position. Release the brakes only when transporting the unit.

## Packing CritiCool for Shipment

Please follow these instructions to properly prepare CritiCool for transport. Empty the water tank prior to packing CritiCool.

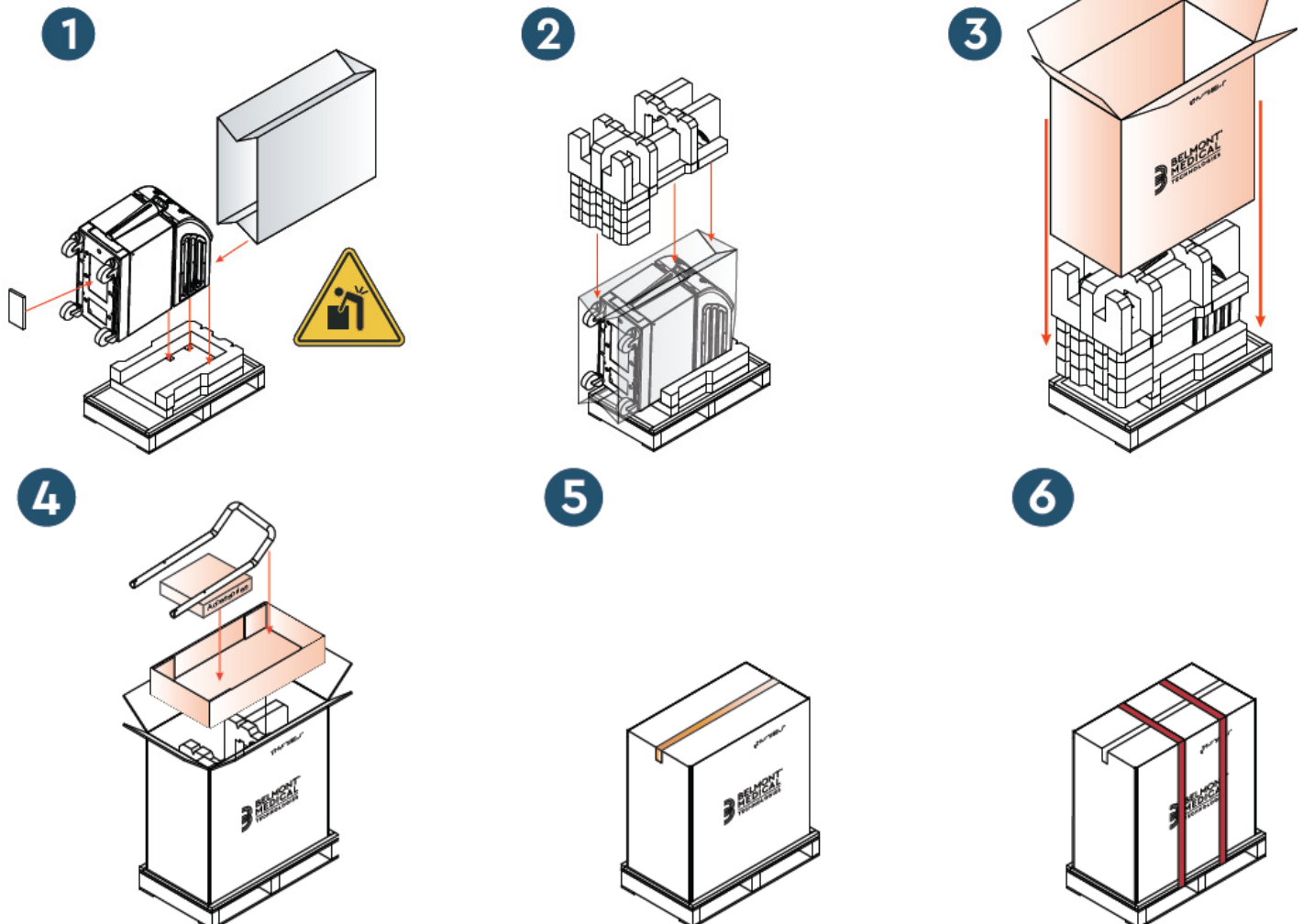

## CHAPTER 4: OPERATING INSTRUCTIONS

### *General*

This chapter contains:

- A description of the controls, indicators and connections for the CritiCool® system
- Detailed operating instructions for the CritiCool® system for the different modes of operation.

## ***CritiCool Functions***

CritiCool® is used for patient thermoregulation.

Patient thermoregulation includes the following modes:

- TTM: Targeted Temperature Management
- Controlled Rewarming: Slow rewarming
- Normothermia: Fast warming

CritiCool starts up in one of two patient modes, Adult or Neonatal, depending on the chosen settings. The default settings are different for these two modes. Both can be set by the user per the protocol used at each hospital. The user should set the appropriate patient mode in Settings when setting up the machine. See page 46 for further instruction.

CureWraps are available to fit patients of varied size and weight.

## Controls, Functions, Indicators and Connections

### Main Power Switch





The main power switch, located at the rear of the unit, switches the CritiCool® system ON and OFF.

The self-test panel is displayed (See page 40). At the end of the Self-Test, an alarm is automatically activated.

### CritiCool® Screen Controls

The CritiCool® screen is a touch screen, with additional hard keys to the right of the panel:

**Table 4: CritiCool® screen keys**

<i>Icon</i>	<i>Description</i>
	<b>Main Menu and Escape</b>
	<b>Show Graph / Change Graph Parameters</b>
	<b>Alarm Tone ON/OFF</b>
	<b>Open Setting Panel / Change Setting</b>
	<b>Accept Change</b>

**NOTE:** The alarm icon is an informative icon only. To silence an alarm, the user must press the hard key of the alarm, located to the right of the panel.

## QCC— Quick Coupling Connectors

The Quick Coupling Connectors are located at the front of the CritiCool® device (see circles below) and are connected to the Wrap by the connecting tubes.



Quick Coupling Connectors

### To connect the connecting tubes:

1. Lock the connecting tubes by pressing the metal ends of the tubes into each metal connector on the device (see below); when locked, a clicking sound is produced.



2. Verify that the tubes have been locked by lightly tugging them towards you.

### To disconnect the connecting tubes:

1. Press the metal flange and pull out the connecting tubes.

## Temperature Probe Sockets

There are two temperature probe sockets located at the front of the CritiCool® device above the Quick Coupling Connectors:

- Core – for the core temperature probe or adapter cable
- Surface – for the surface temperature probe or adapter cable

## Patient Thermoregulation – Step by Step Operation

### To prepare the system for operation:

1. In an area away from patient care, remove the water tank feeder cover and pour in sterile water until the maximum allowable level is reached.

**NOTE:** Sterile water is recommended. 0.22 micron filtered tap water may also be used.

2. Observe the water-level indicator to prevent overfilling the water tank. Close the water tank feeder cover.

**NOTE:** In case of overfilling, see Table 18.

3. Place the unit in the desired position according to “Space and Environmental Requirements”.
4. Press the brake pedals and lock the wheels to secure the CritiCool® device.
5. Connect the CritiCool® device to the power source.

## Operating the System

### To turn on the system:

1. Turn the main power switch upwards to the ON position. The Self-Test panel is displayed (see Figure 8). At the end of the Self-Test, the alarm is automatically activated.

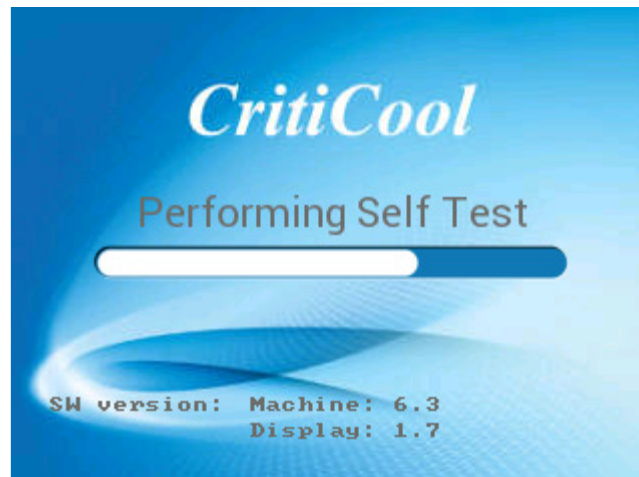

**Figure 8: Self-Test Screen.**



**NOTE:** The CritiCool® system is equipped with self-testing routines that continuously monitor system operation.

**NOTE:** The Self-Test will occur only if the CritiCool® system has been shut off for at least ten minutes. If you wish to use the system after it has been shut off for less than ten minutes, the system will start up in the last screen it was in. The Self-Test will not initiate, and you will need to use the Menu button to navigate to the preferred mode of operation or desired screen.

2. Following the short Self-Test, the system automatically starts to cool the water to 13°C through internal circulation (as in Standby Mode) (See Figure 13 on page 51).
3. Select the appropriate wrap, remove it from the package and place it on the bed or underneath the patient. (See Table 2: CureWrap®).

**NOTE:** When using CritiCool in TTM mode, it is highly recommended to let the CritiCool® run before connecting temperature probes and hoses to allow the water to cool.

**NOTE:** When using CritiCool to warm a patient, it is highly recommended to fully set up CritiCool and the patient probes before turning on CritiCool® to prevent the water from cooling upon powering.

**NOTE:** Do not wrap the patient at this time. The Wrap should not be fastened around the patient until it has filled with water.

## Inserting and Attaching Temperature probes

**WARNING!!!** For proper use of the CritiCool® system, the core temperature probe must be inserted, and the surface temperature probe must be attached to the patient per the probes' instructions for use. The location of the surface temperature probe is a clinical decision. All temperature probes directly measure temperature.

1. Insert the core temperature probe or gray adaptor cable (reusable or disposable) into the right socket labeled "CORE" color-coded with gray on the front of the device. (See Figure 2 on page 19).
2. Insert the core temperature probe (reusable or disposable) into the patient's rectum or esophagus.
3. Insert the surface temperature probe or green adaptor cable (reusable or disposable) into the left socket labeled "SURFACE" color-coded with green on the front of the device.
4. Attach the surface temperature probe (reusable or disposable) to an exposed area of skin with adhesive tape. When the patient is wrapped, the surface temperature probe should not be under the CureWrap or covered.

**CAUTION!** The CritiCool® system does not initiate thermoregulation if the core probe is not properly inserted into the patient. Ensure that direct patient feedback is monitored at all times.

### NOTES:

- The disposable temperature probes need to be connected to an adapter. Make sure to connect the appropriate probe to its adapter (note the labeling on the adapter).
- Be sure to read and follow the instructions for use of the temperature probes being used, paying particular attention to indications and contraindications.
- Regarding core and surface adapter cables PN# 014-00028 and PN# 014-00129 specifically:
  - Carefully inspect the adaptor cable before use
  - Ensure correct fit
  - Use with 400 series medical electronics
  - Wait for the probe temperature to stabilize
  - Route the adaptor cable carefully to avoid patient entanglement and strangulation
  - Do not damage or modify adaptor cables
  - Do not boil or autoclave

## Connecting the Water Hoses (Tubes) to CritiCool

The Quick Coupling Connectors (QCC) are located at the front of the CritiCool® device. See page 39.

### To connect the water tubes to CritiCool®:

1. Before connecting the water tubes, press the metal flange on each QCC to ensure 'open position' of the connector.
2. Lock the connecting tubes by pressing them against the connectors. When locked, a clicking sound is produced.
3. Verify that the tubes are locked by lightly tugging them towards you.
4. Connect water tubes to wrap and to CritiCool®, listening for a click upon each connection. Open the clamps on the wrap, if necessary.

**NOTE:** If the tubes are not properly connected to the device, or the clamps to the wrap are closed, water will not flow to the wrap, and, if a mode has already been selected, you will notice the disappearance of the OK symbol in the top left corner of the screen.

### To disconnect the tubes:

- Press the metal flange and pull out the connecting tubes.

**WARNING!!** Water may drip from the inlet tubes of the wraps. Be sure that no electrical device or outlet is located under the CritiCool's® water inlet or wrap tubes. When disconnecting wraps from the CritiCool®, confirm that the clamps are tight to prevent water leaking from the wrap.

**NOTE:** Select the corresponding connecting water tubes according to the Wrap in use. 2x3 Way Connecting Tubes (Part Number 200-00147) may be needed for CureWraps PED-XL008 and will be required for Adult CureWraps 508-03500. All other CureWraps will require 2x2 Way Connecting Tubes (Part Number 200-00109).

## Activating the System

After the self-test, the Select Mode screen appears with Targeted Temperature Management (TTM) mode highlighted.

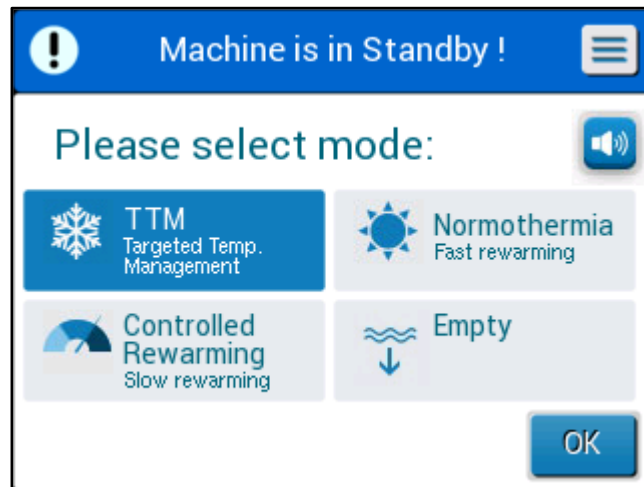

**Figure 9: Mode Select Upon Startup**

4. Touch the required mode, then touch **OK**.  
The Thermoregulation Main Screen Control Panel appears, and because all connections have been made, the Wrap will begin to fill.

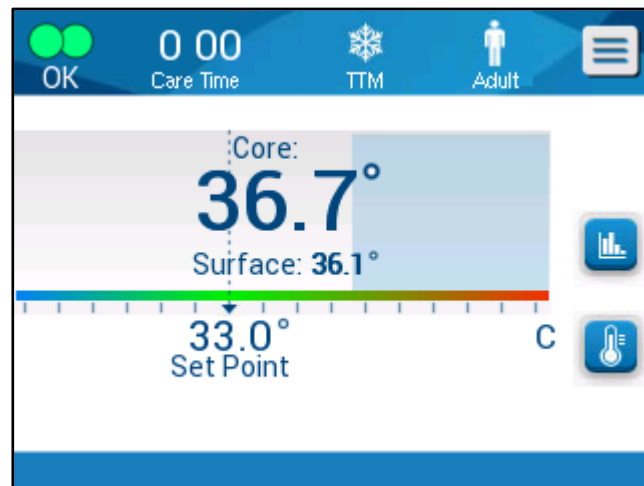

**Figure 10: Main Screen**

Once CritiCool® is turned on, all operating functions are controlled by the LCD Touch Screen. Alternatively, the control panel's hard keys and visual displays guide you through each operational phase as well.

The CritiCool® system is now operational and preparing itself for the start of therapeutic treatment.

At this time, confirm that the Patient Mode is set to your desired choice (Adult / Neonatal). If you wish to change the selection, refer to Patient Mode on page 46.

**NOTE:** Confirm that the Patient Mode shown to the left of the Menu button indicates the desired Patient Mode (either **Adult** or **Neonatal**). If it needs to be changed, change the mode in Settings; refer to page 46 for further instruction.

## Wrapping the Patient

After the desired mode has been chosen and water has filled the wrap, the CureWrap can be positioned around the patient. Follow the CureWrap Instructions for Use pamphlet DLW136003 when wrapping the patient, being careful to keep a finger's breadth between the patient and the wrap.

**NOTE:** Before securing the wrap to the patient with the Velcro strips, confirm that the wrap has filled with water.

**NOTE:** If the wrap is soiled, replace the wrap. Select the corresponding connecting tubes according to the wrap in use.

## The Control Panel

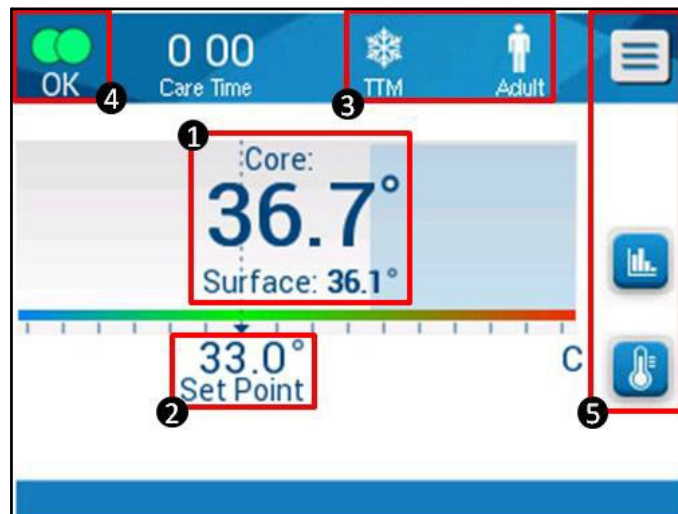

**Figure 11: The Control Panel.**



The Control panel displays the following:

- Patient Core and Surface Temperatures ①
- Set Point Temperature ②
- CritiCool® Mode and Patient Mode ③
- **OK** indicator to indicate that water is flowing into the wrap and the system is functioning correctly ④
- Action Icons and Touch keys ⑤

- **Menu**  / **Escape** 

- Alarm ON 

**NOTE:** The Alarm icon appears only if there is an Alarm condition. This icon is informative only and not an action button (It is not a touch button).

- Graphical Display of CritiCool® Parameters 
- Set Point / Target Temperature Control 

## Patient Mode

The Patient Mode affects alarm conditions as well as the default set point.

Patient Mode is designated by one of two icons:

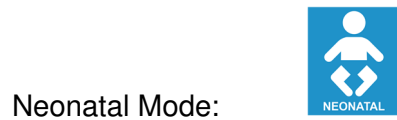
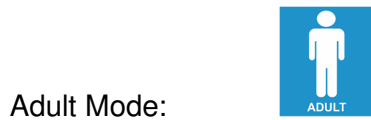

To adjust the Patient Mode, press **Menu** .

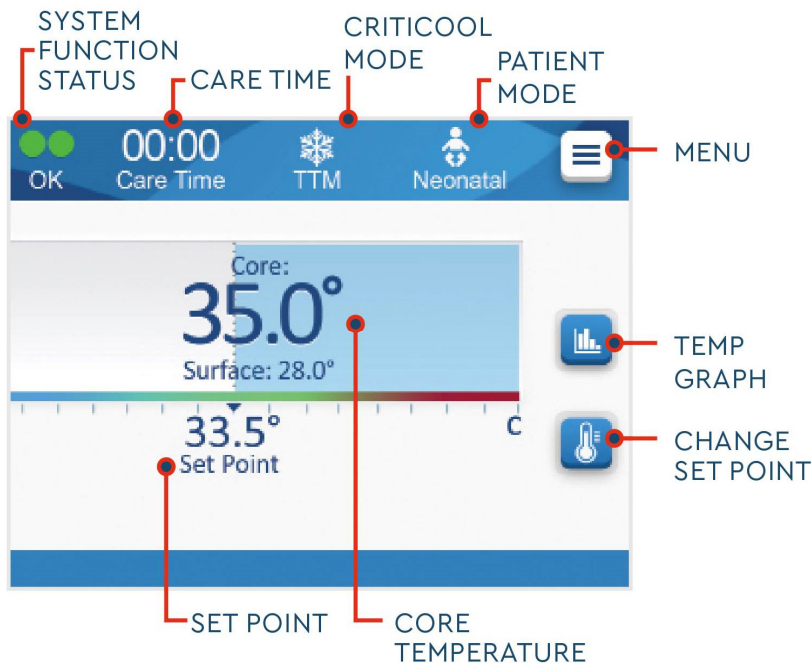

A list of options appears.



Press **Settings**. You will be asked to enter the passcode, which can be found in the manual under Settings on page 55. Enter the code and then press **OK**.

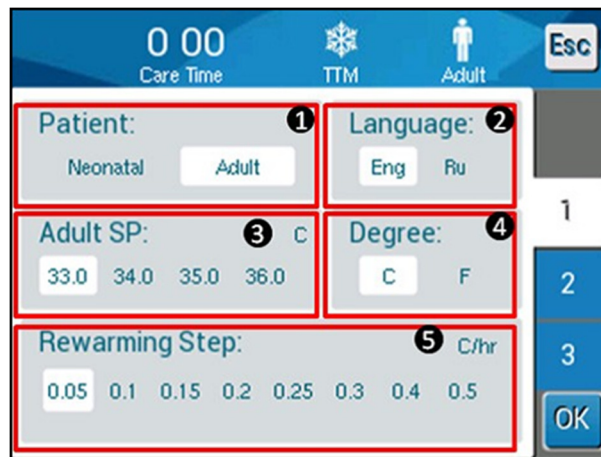

Settings Screen 1 will appear (see below).

Patient Mode is displayed in the top left section titled “Patient”. The selected Patient Mode is highlighted with a white box. In this scenario, Adult Mode is selected.

To select a different mode, press the desired Patient Mode, either **Neonatal** or **Adult**. The new Patient Mode will now be highlighted with a white box. Press **OK** to finalize the change.

**NOTE:** The Neonatal and Adult modes have different settings during operation.

The Main Screen will now show the new Patient Mode icon upon full restart.

## Neonatal Mode



The Neonatal Mode is designated by this icon:

**Neonatal Mode has a default Set Point (SP) Temperature of 33.5°C (92.3°F).**

If required by clinical protocol, change the Set Point by using the Set Point key on the Main Screen: See page 60 for more detail.



**NOTE:** If the machine is shut off and a time lapse of ten minutes or more occurs, the set point will return to the factory setting of 33.5°C for TTM in Neonatal Mode.

In Neonatal Mode, when the message “Core Readout too Low” appears indicating that the core reading is at least 2.0°C below the Set Point or the patient Core Temperature is below 31.0°C: Thermoregulation is paused, and water stops flowing to the wrap.

See page 80 for more detail.

## Adult Mode



The Adult Mode is designated by this icon:

**Adult Mode has a default Set Point (SP) Temperature of 33.0°C (91.4°F).**

If required, change the Set Point by using the Set Point key on the Main Screen (see right).



**NOTE:** If the machine is shut off and a time lapse of ten minutes or more occurs, the set point will return to the factory setting of 33.0°C for TTM in Adult Mode.

The Default Set Point temperature can also be changed and will be the new set point in Adult Mode upon restarting. To change Default Set Point Temperature for Adult Mode, press **Settings**. You will be asked to enter the passcode, which can be found in the manual under Settings on page 55. Enter the code and then press **OK**.

Settings Screen 1 will appear.





Adult Set Point is displayed in the top left section below “Patient”, and it is titled “Adult SP”. The selected default set point for Adult Mode is highlighted with a white box. On the screen shown, 33.0 is selected.

To select a different default set point for Adult Mode, press one of the other default set point options.

Options for Default Adult Set Point include:

- 33.0°C
- 34.0°C
- 35.0°C
- 36.0°C

The new chosen Default Set Point will now be shown in a white box.

Press **OK** to finalize the change.

The Main Screen will now display the new Default Set Point.

**NOTE:** *Adult Mode triggers different responses than Neonatal Mode.*

In Adult Mode, when the message “Core Readout too Low” appears indicating that the core reading is at least 2.0°C below the Set Point or the patient Core Temperature is below 31.0°C: the following operating conditions occur:

**If Core > 31.0°C:** Thermoregulation is paused, but the machine continues to flow **cold water** to the wrap, so the patient does not rewarm.

**NOTE:** This differs from Neonatal Mode.

**If Core < 31.0°C:** Thermoregulation is paused, and water stops flowing to the wrap.

## The Main Menu



When you touch the Menu icon , a list of options appears.



*Figure 12: Main Menu.*

The options include the following:

- Standby
- Mode Select
- Temp Graph
- Settings
- Services

## Standby Mode

Use Standby mode in instances when the circulation of water to the wrap is temporarily required to stop (for example: for transport or CT/MRI imaging). It is recommended to put the system in Standby prior to shutting it off.

In this mode, there is neither external water circulation nor thermoregulation. The CritiCool® system keeps monitoring patient temperatures and circulating the water internally, cooling it down to 13°C.

**NOTE:** No alarms will occur when the system is left in Standby Mode. Because no thermoregulation occurs in this mode, if a patient is left in Standby Mode for extended periods of time, the patient may become too warm or cold. It is important for the patient to be monitored by the clinical team during all phases of treatment, including when CritiCool is in Standby Mode.

### *To go to Standby:*



1. Touch the MENU icon .
2. Touch **Standby**

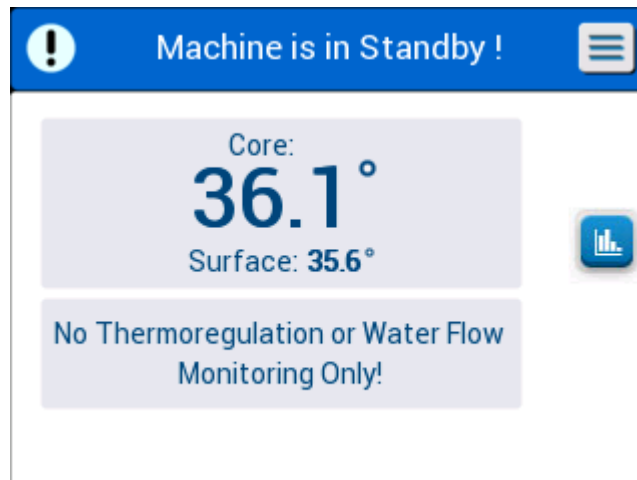

*Figure 13: Standby Mode*

## Mode Select

The MODE SELECT panel enables selecting a mode of operation.

### To select a mode:



1. Touch the MENU icon .
2. Touch **Mode Select** to display the select mode panel.

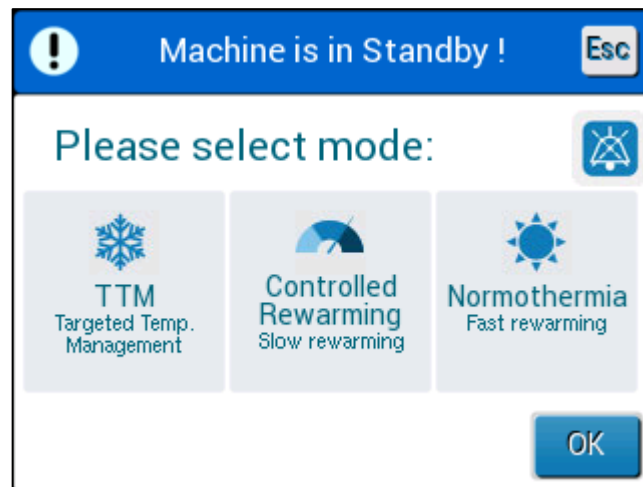

**Figure 14: Select Mode Panel**

3. Touch the required mode icon. The selected mode will be highlighted in blue.

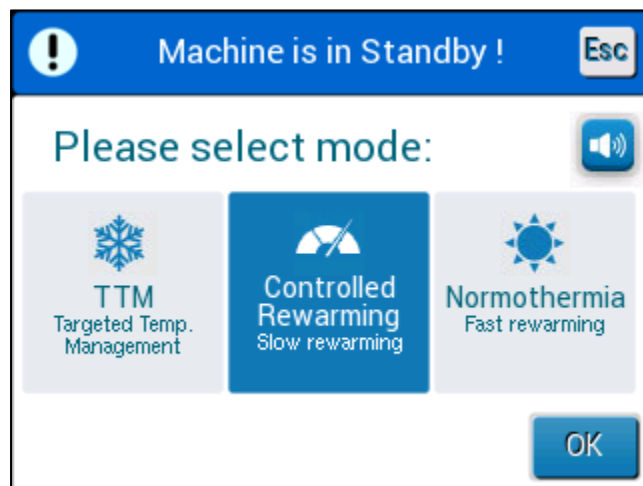

4. Touch **OK** to activate the mode.

**NOTE:** The selected mode is shown at the top of the control panel (see “the Control Panel”).

The modes of operation include the following:

- **TTM (Targeted Temperature Management)**
  - Adult/Neonatal setting impacts operation in TTM Mode. See Patient Mode for additional information.
- **Controlled Rewarming**
  - Adult/Neonatal setting does not impact operation in Controlled Rewarming Mode.
- **Normothermia**
  - Adult/Neonatal setting does not impact operation in Normothermia Mode.

### ***TTM (Targeted Temperature Management)***

Use TTM mode for targeted temperature management.

This mode is also useful for any procedure where thermoregulation is required to bring the patient's temperature to a stable set point temperature as quickly as possible.

### ***CONTROLLED REWARMING***

This mode provides controlled gradual rewarming. The set point temperature is increased by a fixed, small step for a predefined period.

The step is always related to the core temperature reached at the end of the previous stage. In the Settings screen, you can choose the final Target Temperature and the rewarming step rate.

### ***NORMOTHERMIA***

Normothermia mode is for fast warming for cases in which a patient needs to be warmed quickly. This mode should not be used for patients undergoing cooling therapy.

**NOTE:** When switching to Normothermia Management, the system keeps the last set point of the preceding mode.

More detail on all modes of operation is provided on page 60.

## Temperature Graph



The temperature graph may be shown through the main menu or via the Temperature Graph Icon.



CritiCool® displays either the Current Case parameters or the last session.

If the wrap or temperature probes are not connected, the last case is displayed.

### To select Temp Graph:

1. Touch the MENU icon. 
2. Touch the Temperature Graph icon. 
3. Once entering the temperature graph, the following is shown:

**NOTE:** The Surface Temperature Graph can be displayed or hidden.

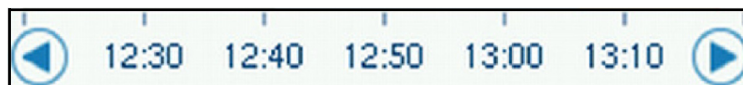

**Figure 15: Temperature Graph.**

The date is displayed at the top of the graph.

The time from the beginning of the procedure is displayed on the X axis. The temperature is shown on the Y axis.

Move forward or backward the time of the graph displayed by using the arrow keys.



The screen can show 1 hour, 6 hours, 12 hours or 24 hours. Use the double arrows to select the time range.



## Settings

The settings panels consist of four pages of default settings for the system.

**NOTE:** *The settings menu is password protected and is available from a Belmont Authorized Representative. Only authorized personnel may change the settings.*

**The passcode for the Settings screen is \_\_\_\_\_.**

### To pre-configure the settings:

1. From the Menu panel, choose **Settings**.
2. Enter the password. The Settings window appears.
3. Touch the page numbers to move between the pages.

### Settings Screen 1



**Figure 16: Settings Screen 1**

Settings Screen 1 includes:

- Patient Mode: Adult or Neonatal ①
- Language ②
- Default Set Point Temperature for Adult Mode ③
- Temperature Scales (Celsius/ Fahrenheit) ④
- Rewarming Step for Controlled Rewarming Mode ⑤

## Settings Screen 2

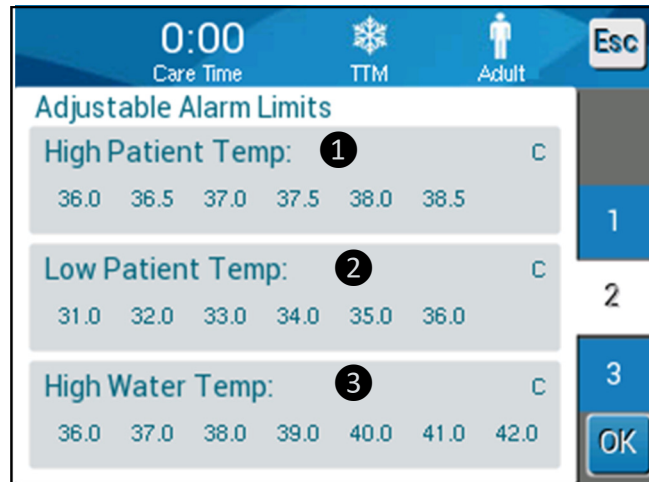

Figure 17: Settings Screen 2

Settings Screen 2 includes adjustable alarm limits for:

- High Patient Temperature ①
- Low Patient Temperature ②
- High Water Temperature ③

## Settings Screen 3

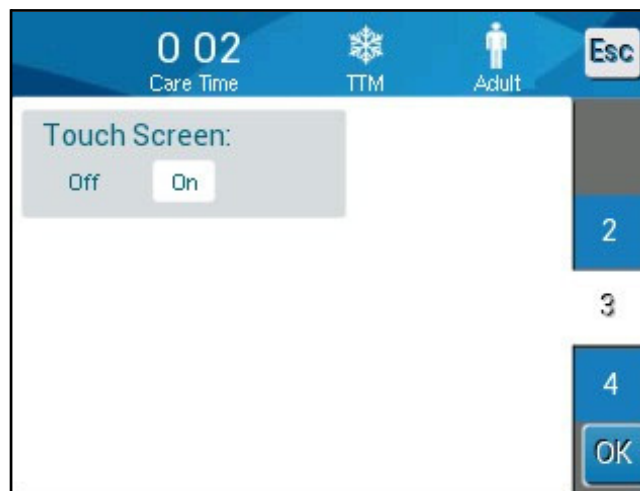
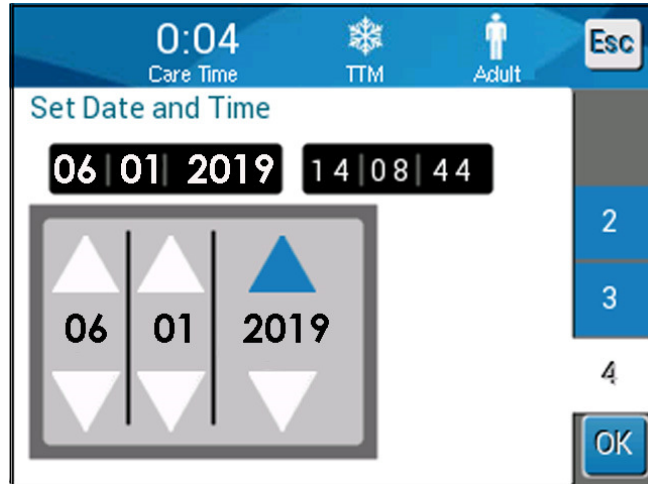

Figure 18: Settings Screen 3

Setting Screen 3 includes the touch screen ON/OFF option.



## Settings Screen 4



**Figure 19: Settings Screen 4.**

Setting Screen 4 includes the Time and Date settings. Touch the digit you wish to change and then adjust using the up and down arrows.

4. Touch **OK** to confirm settings changes and to return to the control panel.

**NOTE:** Touching the ESC soft key returns to the main screen without saving any changes.

## Services

The Services option is in the Menu panel. Services include the following:

- Empty
- System Check
- Technician
- Thermal Disinfection

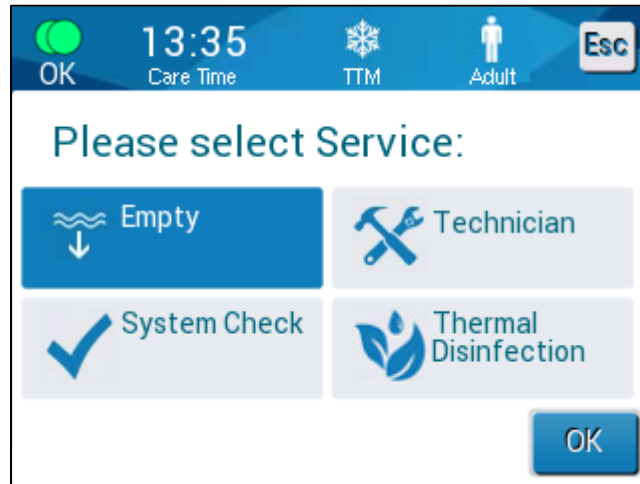

The System Check, Technician and Thermal Disinfections services are discussed in CHAPTER 6: MAINTENANCE.

### *Empty*

This service allows emptying the system of the remaining water, prior to storing CitiCool®.

#### ***To empty the water tank:***

1. In an area away from patient care, with the system powered off, tightly clamp and then disconnect the wrap from the connecting water tubes. Dispose of the wrap.
2. Connect a male draining connector to the "water out" of the connecting water tubes and direct the tube to a bucket or sink for water collection.
3. Power on the system.
4. Choose **Empty** on the main screen, or navigate to **Empty** by touching the **Menu** icon , then selecting **Services**, then **Empty**.
5. Press **OK**. The following screen appears.

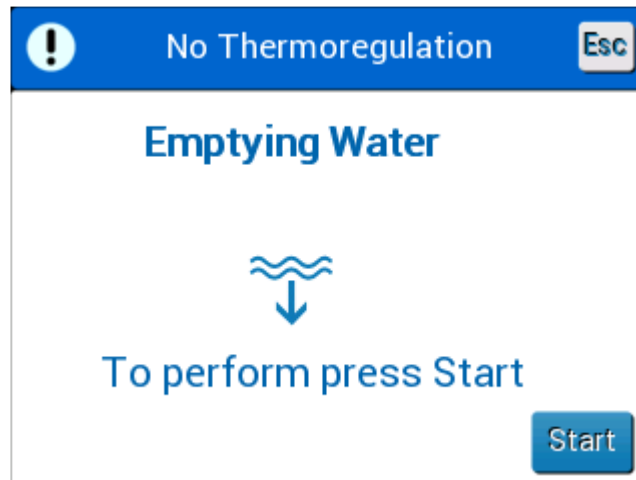

*Figure 20: Start Emptying Panel.*

6. When you are ready for the process to begin, touch Start. The following screen appears.

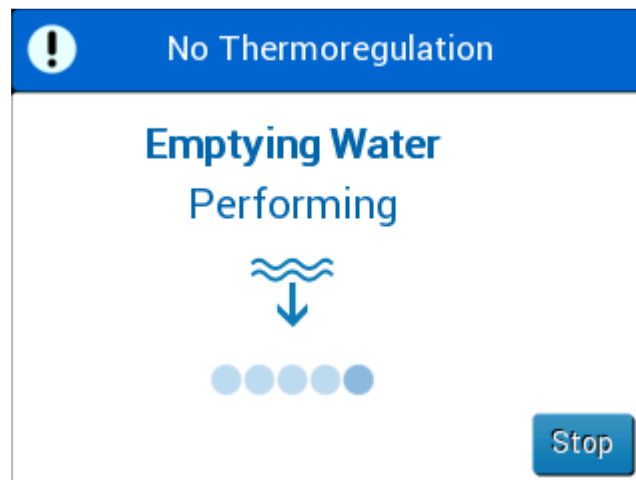

*Figure 21: Emptying Water - Performing Panel.*

When the water has been emptied completely, a message appears stating that CritiCool® is now empty.

After emptying the system, shut down the system. First, put the machine into Standby Mode by pressing **Menu**, then **Standby**. Then turn the main power switch downwards to the OFF position. The main power switch is found on the rear of the device.

CritiCool® is now ready for storage until the next procedure.

For further instruction on after use care, consult “Before Storage” on page 90.

## Modes of Operation

### Targeted Temperature Management (TTM) Mode

Upon startup, the CritiCool® system prompts the user to confirm the mode, and an audio alarm sounds. TTM is highlighted by default.

When a mode is selected, a default Set Point (SP) temperature appears on the Main Screen (see Figure 11 on page 45).

The Set Point is the target temperature to which the thermoregulation system cools or warms the patient's body.

For Neonatal Mode, the set point default for TTM is 33.5°C (92.3°F).

For Adult Mode, the set point default for TTM is 33.0°C (91.4°F).

**WARNING!!!** *The default setting is intended to maintain TTM.*

In the Adult Mode, there is an option to configure the default set point temperature in the Settings screen (range is between 33 °C to 36 °C in steps of 1°C). The default Set Point temperature that is configured will be the Set Point temperature for the machine upon start up.

After start up, it is possible to change the TTM Set Point temperature in either patient mode for the current patient using the Set Point icon.

The system provides the physician with the option of selecting a body temperature in the range of 30°C-40°C (86°F-104°F).

**WARNING!!!** *The desired set point temperature should only be set by the physician or under the order of a physician.*

#### To change the set point temperature

1. Touch the Set Point icon  to display the Set Point Setting screen.

2. Use  and  to select the Set Point Temperature.
3. When finished, touch **OK**.

**NOTE:** The  and  icons change the temperature by 0.1°C. Pressing the temperature scales changes the temperature by 1°C.

After adjusting the set point, the CritiCool® system automatically operates at the optimal level to obtain the desired set point temperature. The set point should therefore be set upon mode selection and not changed until the patient needs to be rewarmed or there is another need to change the desired patient temperature.

**NOTE:** *The rate of temperature change depends on the size and weight of the patient.*

**NOTE:** *When there is a difference between the set point temperature and the core temperature, a further decrease in the set point temperature does not affect the water temperature in the wrap.*

Short transient changes in core temperature do not affect thermoregulation and are compensated by the system.

When the core temperature is too low, an alarm and a message appear.

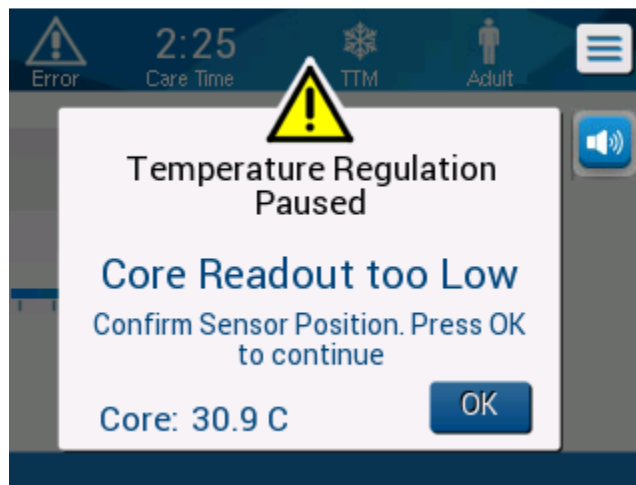

**Figure 22: Core Readout Too Low Message**

The message appears when core temperature is at least 2°C lower than the set point or when the core temperature is below 31°C.

**In Adult Mode:** Water continues to flow to the wrap as long as the patient temperature is above 31°C.

**In Neonatal Mode:** Water immediately stops flowing to the wrap. Check if the core sensor is correctly inserted and the reading is correct:

- If the sensor needs repositioning, reposition and recheck temperature; touch **OK** to restart temperature management.
- If the temperature is correct, touch **OK** to restart temperature management.

**CAUTION!** *Check that the core sensor is properly set into the patient and touch OK to confirm the core temperature.*

**NOTE:** If you disregard the message and do not touch OK for over 30 minutes, the alarm cannot be silenced until the OK button is touched.

When you touch **OK**, the screen returns to the Main Screen and a message appears for 5 seconds to indicate that thermoregulation has resumed.

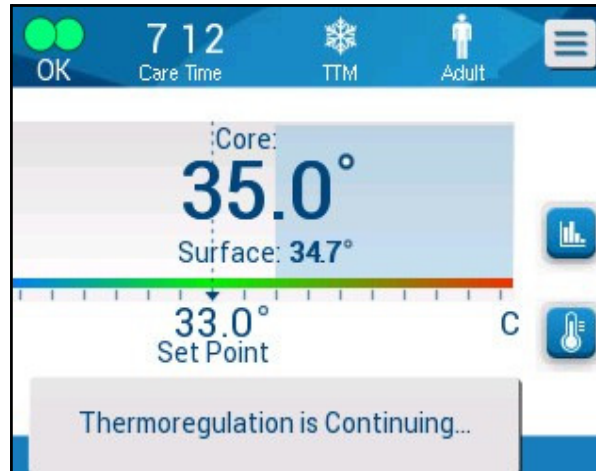

**Figure 23: Thermoregulation is Continuing Message**

## Controlled Rewarming Mode

This mode is used for Controlled Rewarming following TTM.

In Controlled Rewarming Mode, CritiCool® increases the set point automatically in small steps until it reaches a normothermic target temperature.

## Controlled Rewarming Process

The Controlled Rewarming process starts with the patient at a mild hypothermia temperature. According to the pre-determined steps of rewarming, the system elevates the patient's temperature, each unit of time, to a Virtual Set Point (VSP).

For example: The patient core temperature is 33.5°C and the selected step temperature elevation is 0.4°C/1 hour. The first step of the process is to increase the Virtual Set Point by 0.2°C: to 33.5 + 0.2 = 33.7°C over a period of 30 minutes.

Assuming that at the end of the 30 minutes period, the core temperature has reached 33.7°C, the Controlled Rewarming algorithm adds 0.2°C to the last virtual set point and the new virtual set point is now 33.7 + 0.2 = 33.9°C for an additional 30 minutes, and so on, until the core temperature reaches the target temperature.

**NOTE:** To calculate the next VSP, the algorithm takes TVSP ( $n$ ), and selects  $TVSP (n+1) = TVSP (n) + \Delta$ , irrespective of the TC of the patient.

*If, however there is an additional effect, such as spontaneous increase in body temperature of  $+\Delta SP$  or spontaneous decrease in temperature of  $-$*

$\Delta SP$ , the algorithm halts the spontaneous change in temperature and forces the patient to the set VSP.

**NOTE:** The rewarming rate chosen in Settings is the desired average rewarming rate over the course of the rewarming period. It would not be unusual if a patient warmed more in one period and less in another, as the algorithm compensates based on actual patient temperature, adjusting for multiple factors.

**To set the rewarming step:**



1. Touch the MENU icon .
2. Touch **Settings** in the Menu.
3. Insert password and press the **OK** button.
4. Choose the desired Rewarming Step per hour.
5. Touch **OK** to return to the Main Screen.

**To Start Controlled Rewarming:**



1. Touch **MENU** icon .
2. Touch Mode Select to open the **MODE SELECT** panel.
3. Touch **Controlled Rewarming**.

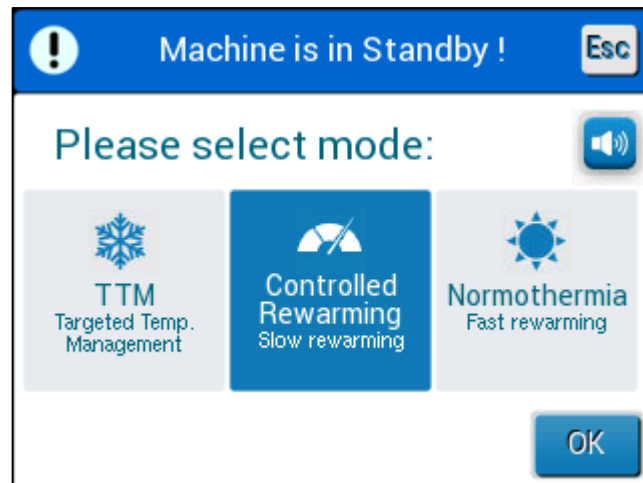

**Figure 24: Select Mode Controlled Rewarming.**

4. Touch **OK**.

A message appears: “Switching to AutoRewarm Mode. Confirm Core in place and press OK.”

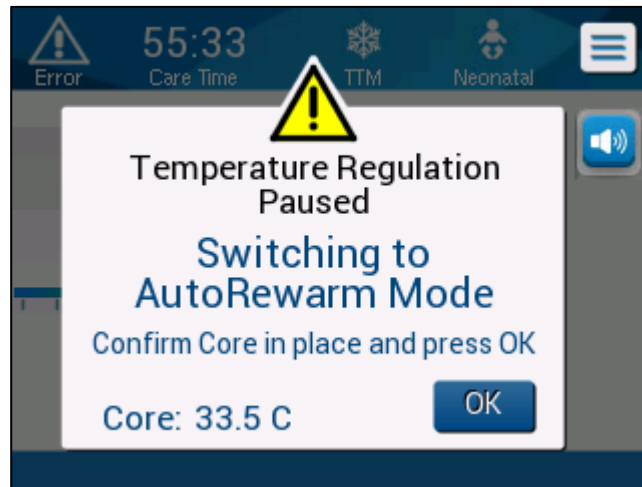

**Figure 25: Switching to Rewarming Message.**

5. Touch OK to confirm correct core temperature and to start the rewarming process.



6. Use the set temperature icon to change the target temperature.

**NOTE:** The target temperature is the temperature at which the controlled rewarming process ends. In the "Controlled Rewarming" mode, the set point display changes to "Target Temp." with a default of 36.5°C.

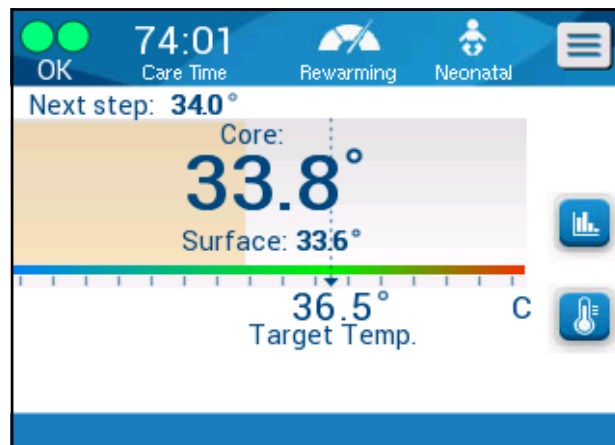

**Figure 26: Controlled Rewarming Mode.**

CritiCool® heats the water and starts circulation. The flow icon starts to move. The system proceeds to increase the virtual set point until the target temperature is reached.

**NOTE:** In the main screen, the "Next Step" shows the VSP / 0.5 hour.

When core temperature reaches the target temperature, CritiCool® continues to maintain the body temperature according to the target temperature.



If, during the Controlled Rewarming phase, the core temperature becomes more than 2 degrees below the target temperature, the following message appears:



**Figure 27: Temperature Regulation Paused Message**

Check that the core probe is inserted correctly in the patient and then touch **OK** to continue Rewarming.

**NOTE:** While this screen is displayed, the machine is not thermoregulating the patient and there is no water flowing to the Wrap!

## Target Temperature Setting



The Target Temperature Setting option enables selecting the Rewarming Target Temperature and is available only in the Controlled Rewarming mode.

The Target Temperature can be set between 30.0°C (86.0°F) to 40.0°C (104.0°F) with a default of 36.5°C (97.7°F).

**NOTE:** This panel is accessible only in the Controlled Rewarming mode.

### To change the Target Temperature:

1. Touch the Set Point/Target Temp icon .

2. Use  and  to modify the target temperature.

**NOTE:** The  and  icons provide a change of 0.1°C. Each scale mark in the toolbar provides a change of 1°C.



**Figure 28: Target Temperature Setting Panel**

3. Touch **OK** to confirm.

## Manual Rewarming

To manually rewarm the patient, remain in TTM Mode once the preferred cooling duration has been reached. Select a set point that is slightly above the core temperature and wait until core temperature reaches the new set point. Then, increase the set point another step and wait for the core temperature to reach the next step.

Repeat the procedure until the patient reaches target temperature.

The set point step and the duration of each step depend on hospital protocol.

When choosing small steps, CritiCool® will keep water temperature close to body temperature. It is recommended to choose steps of 0.2°C – 0.3°C per hour during the rewarming phase.

For fast warming, choose Normothermia mode.

**NOTE:** The desired set point temperature should only be set by the clinician.

## Normothermia Management

Use the Normothermia Mode for warming or cooling a patient to achieve or maintain normothermia.

**NOTE:** This mode is used for fast warming. It does not allow for gradual controlled rewarming.

The CritiCool® system is automatically pre-set in TTM mode. The system can be set to operate in Normothermia mode (see Mode Select on page 52).

## Normothermia

### To achieve Normothermia



1. Go to the **Menu** icon .
2. Choose **Select Mode**.
3. Choose **Normothermia**.
4. Confirm by touching **OK**.

The Main Screen shows Normothermia Mode.





**Figure 29: Normothermia Mode**

**NOTE:** The set point temperature default in Normothermia Mode is that of the last operating mode. Make sure to adjust to desired set point temperature.

**To change the Set Point Temperature:**

1. Touch the Set Point/Target Temp icon .

2. Use  and  to modify the target temperature.
3. Touch **OK** to confirm.

**NOTE:** The icons provide a change of 0.1°C. Each scale mark in the toolbar provides a change of 1°C.

The CritiCool® system automatically operates at the optimal level to obtain the desired set point temperature so that, when in Normothermia Mode, the difference between the set point temperature and the core temperature does not affect the heating rate. A further increase in the set point temperature will not affect the water temperature in the Wrap.

## Exceeding the Normothermia Range

If the desired set point temperature is set outside of the normothermia range (32°C to 38°C / 89.6°F to 100.4°F), the message **OUT OF NORMOTHERMIA** appears.

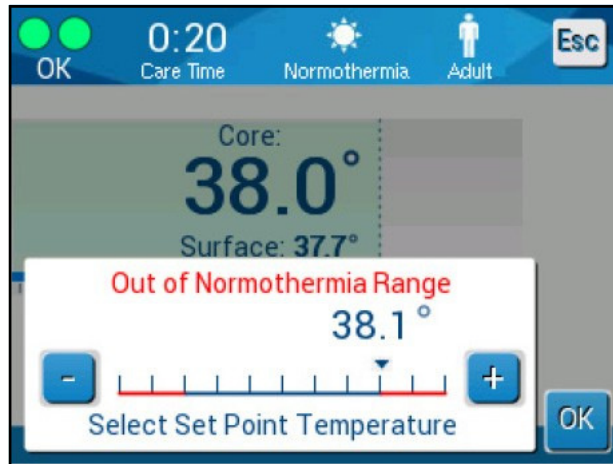

*Figure 30: Out of Normothermia Message*

## ***Replacing the Wrap***

### ***To replace the wrap:***

1. Switch to **STANDBY** and wait for the water return (by gravitation) to the system.
2. Close wrap clamps fully to avoid water leakage.
3. Disconnect the connecting tubes from Wrap.

***WARNING!!!*** *Avoid disconnecting tubes above electrical equipment as mild dripping may occur during disconnection.*

4. Remove the used Wrap and dispose of according to hospital regulations.
5. Add water to the water tank, as needed, up to the 6-liter line.
6. Position the new Wrap underneath the patient (follow the Instructions for Use leaflet supplied with each wrap).
7. Reconnect the connecting tubes to the new Wrap.
8. Confirm that the clamps on the new Wrap are open.
9. Switch back to **OPERATE** mode (press **ESC/Menu** to access).
10. Wait for the new Wrap to fill up with water, then secure it to the patient with the Velcro strips (follow the Instructions for Use leaflet supplied with each wrap).
11. The system is ready.

***NOTE:*** *If there is not enough water in the tank after filling the wrap, the system alert message ADD WATER appears.*

## Operation Panel Messages and Alerts

If the wrap's tubes are connected, temperature probes are connected correctly, core temperature is measured, and an active mode has been selected, water circulation will start without additional user action. If any of the above conditions is not fulfilled, the operation panel message area displays technical and/or clinical alarm messages with a triangular sign. 

**NOTE:** *Clinical alarms represent medium priority alarms while technical messages represent lower priority alarms.*

**NOTE:** *Sound Pressure of the Alarms is 67.5 dBA at a distance of 10 centimeters.*

### Constant alarms occur in the following states:

- Halt condition
- Select mode screen

### The following messages should be checked and confirmed:

- Low Core temperature thermoregulation is continuing...
- Core Readout too Low
- Out of Normothermia Range
- Patient Temperature above XX.X°C (\*)
- Patient Temperature below YY.Y °C (\*)
- Water Temp Too High (\*)

**NOTE:** *Only authorized users can change the range of the alarms marked by (\*) in the Settings screen. The user needs to insert a password to enter the Settings panel and change the alarm limit.*

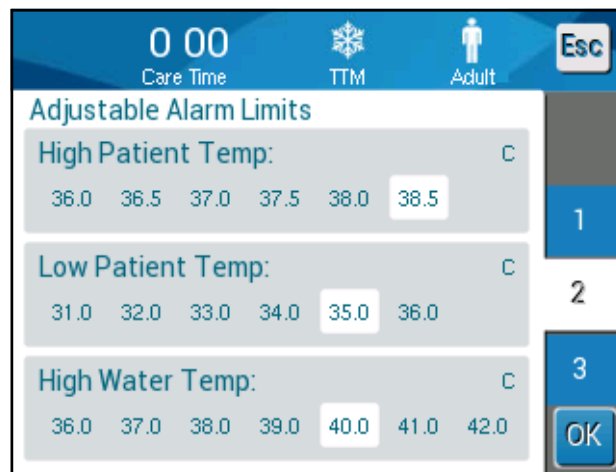

**Figure 31: Adjustable Alarm Limits**

## Safety Messages and Alarms

**NOTE:** During safety messages, thermoregulation stops.

Safety messages alert the clinician that the system has either overcooled or overheated the circulating water.

The safety messages include:

- **WATER TEMPERATURE TOO LOW**



- **WATER TEMPERATURE TOO HIGH**



If such a condition occurs, the user should **shut down** the system and find the cause of the problem.



## Clinical Messages and Alarms

Clinical messages call for the attention of the clinician (doctor or nurse) and refer to the condition of the patient or call for user confirmation of the setting by touching the OK key.

Clinical messages include the following:

**Table 5: Clinical Messages**





<b>Message</b>	<b>Screen Message</b>	<b>Description</b>
<p><b>Core Readout Too Low</b></p>		<p>This message appears when core temperature is at least 2°C lower than set point or when the core temperature is below 31°C. An alarm sounds, thermoregulation stops, and water flow also stops if 1) in Neonatal Mode, or 2) if in Adult Mode and core temperature is below 31°C.</p>
<p><b>Switching to Auto Rewarm Mode</b></p>		<p>Confirm the patient's temperature before switching to Rewarming mode. Once confirmed, touch <b>OK</b> to continue.</p>

Table 6: Clinical Messages

Message	Screen Message	Description
<p><b>Patient's temperature is above 38.5°C</b></p>		<p>For this message, an alarm sounds but thermoregulation continues.</p> <p>The alarm can be muted for 30 minutes.</p>
<p><b>Low Core Temperature</b></p>		<p>This message appears when Core temp. is &gt;0.8°C less the Set Point or according to alarm settings. For this message, an alarm sounds but thermoregulation continues.</p> <p>The alarm can be muted for 30 minutes.</p>
<p><b>Patient's Temperature is below XX.X°C</b></p>		<p>The message appears with an alarm when Core temperature is below the alarm limit preconfigured in the Settings panel.</p>

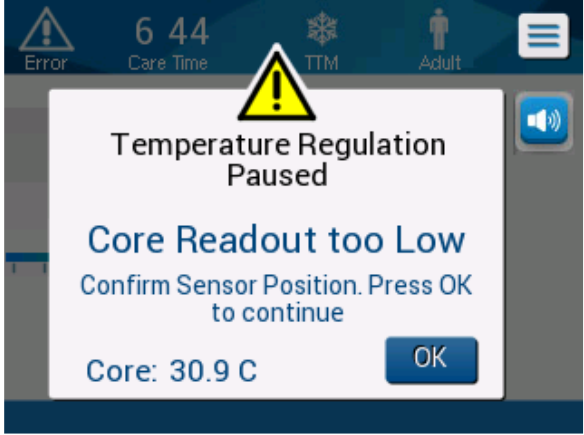
**NOTE:** It is possible to change the range of some of these alarms in the Settings screen.  
 The user can choose at which temperature the "High Patient Temp" and "Low Patient Temp" alarms will be activated.

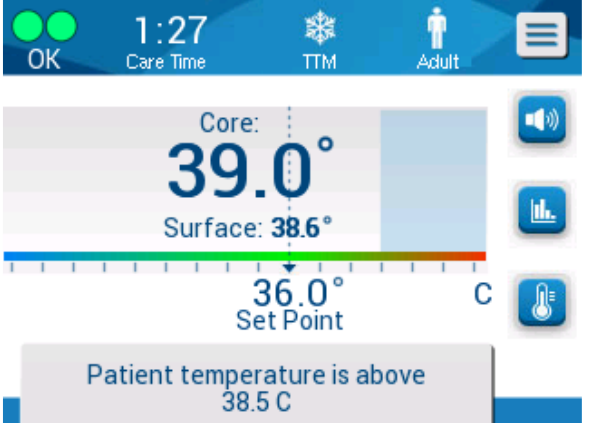
## Technical Messages

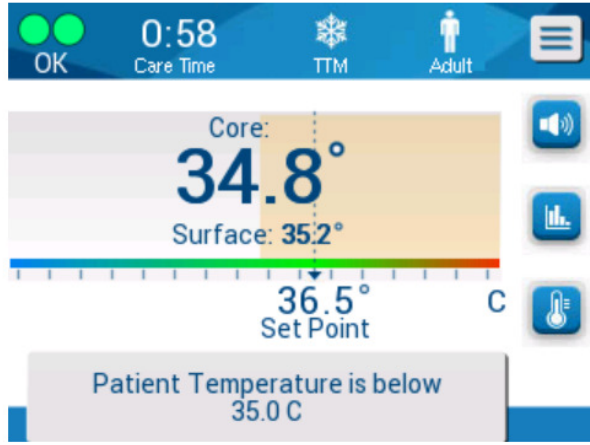
The following technical messages might appear:

**Table 7: Technical Messages and Alarms**

<i>Message</i>	<i>Screen Message</i>
<b>Tank is empty</b>	
<b>Add Water</b>	

Table 8: Technical Messages and Alarms

Message	Screen Message
<p><b>Connect Water Tubes</b></p>	
<p><b>Connect Core Temperature Sensor (Probe)</b></p>	
<p><b>Check Water Tubes</b></p>	

Table 9: Technical Messages and Alarms

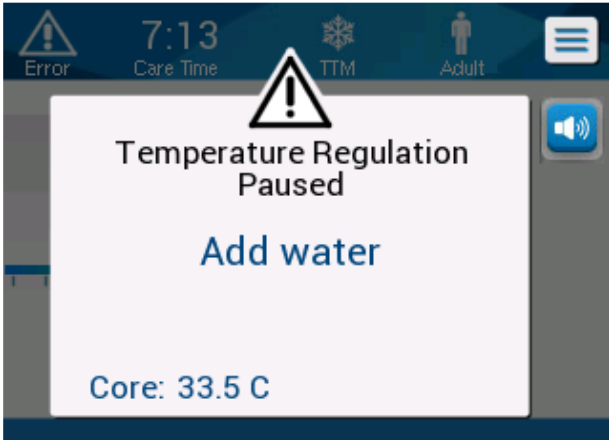

<i>Message</i>	<i>Screen Message</i>
<b>Check Core Temperature Sensor (Probe)</b>	

Follow the instruction of the technical messages, (for example add water if necessary, or connect sensors if they are not connected etc.).

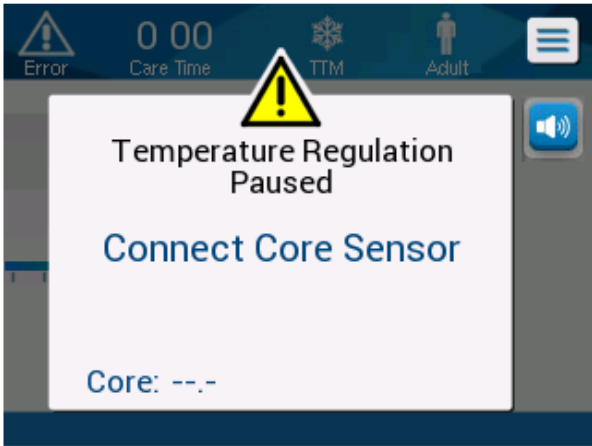
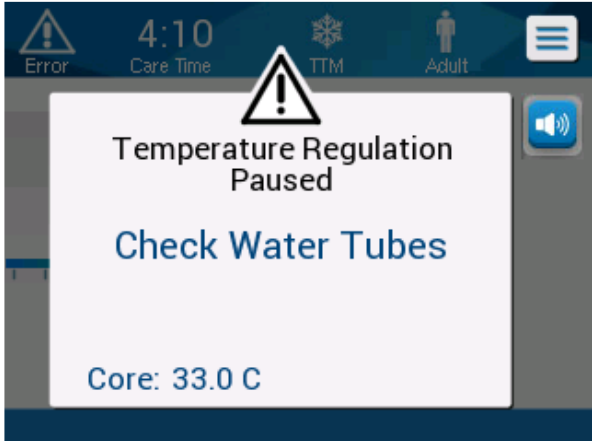
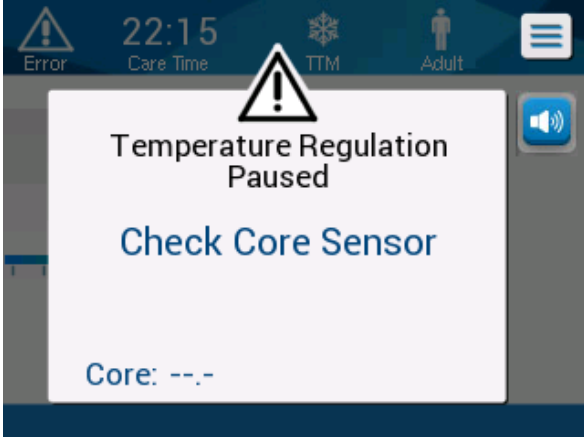
## Informative Messages

Informative messages indicate the status of the machine. These messages are for information only and do not require any user action. The message appears at the bottom of the Main Screen.

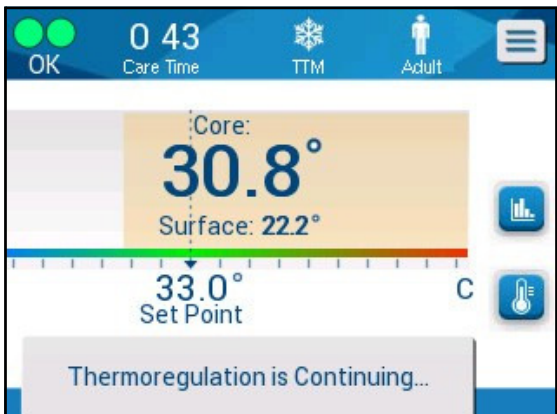
Informative messages include:

<i>Message</i>	<i>Screen Message</i>	<i>Description</i>
<p><b>Body temperature in accepted range</b></p>	 <p>The screenshot shows the main screen with a blue header bar containing 'OK', 'Care Time 0:33', 'TTM', 'Adult', and a menu icon. The main display area shows 'Core: 33.0°' and 'Surface: 32.0°' with a color-coded temperature scale below. A 'Set Point' of 33.0° is indicated. A message box at the bottom reads 'Body temperature in accepted range'.</p>	<p>Appears when core temperature is fixed at an accepted core temperature.</p>
<p><b>Thermoregulation is Continuing...</b></p>	 <p>The screenshot shows the main screen with a blue header bar containing 'OK', 'Care Time 0:43', 'TTM', 'Adult', and a menu icon. The main display area shows 'Core: 30.8°' and 'Surface: 22.2°' with a color-coded temperature scale below. A 'Set Point' of 33.0° is indicated. A message box at the bottom reads 'Thermoregulation is Continuing...'.</p>	<p>Appears after confirming low core temperature for five seconds.</p>
<p><b>Out of Normothermia Range</b></p>	 <p>The screenshot shows the main screen with a blue header bar containing 'OK', 'Care Time 0:20', 'Normothermia', 'Adult', and an 'Esc' button. The main display area shows 'Core: 38.0°' and 'Surface: 37.7°' with a color-coded temperature scale below. A 'Set Point' of 38.1° is indicated. A message box at the bottom reads 'Out of Normothermia Range' and 'Select Set Point Temperature' with '+' and '-' buttons. An 'OK' button is also visible.</p>	<p>Appears when in Normothermia Mode and a Set Point temperature &lt;32°C or &gt;38.0°C is chosen. For this message, thermoregulation continues. Touching <b>OK</b> confirms the new set point temperature and removes the message.</p>

## TTM Mode Messages

The thermoregulation system may have one of three conditions:

### A. Core temperature above the Set Point [ $T_c \geq (T_{sp} - \square)$ ]

In this condition, temperature control starts without any user action.

### B. Core temperature is above 31°C but lower than the Set Point by 0.8°C

[ $31^\circ\text{C} < T_c < (T_{sp} - 0.8)$ ]

In this condition, temperature control continues and warms the patient toward the set point.

An informative message appears and an audible alarm sounds. Pressing MUTE stops the alarm for 30 minutes. The written message on the screen is removed only when  $\Delta \leq 0.6^\circ\text{C}$ .

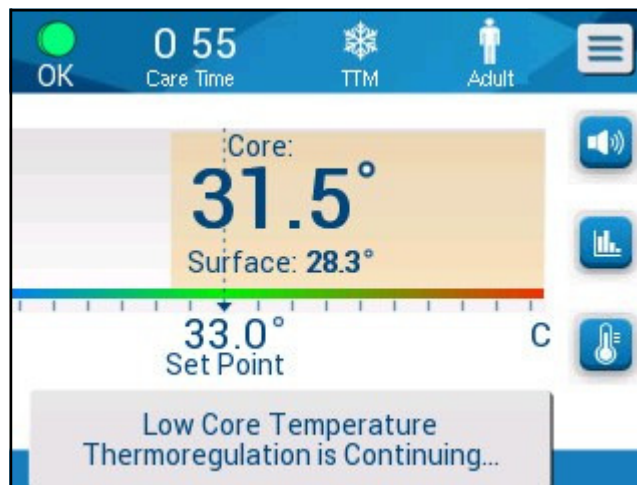
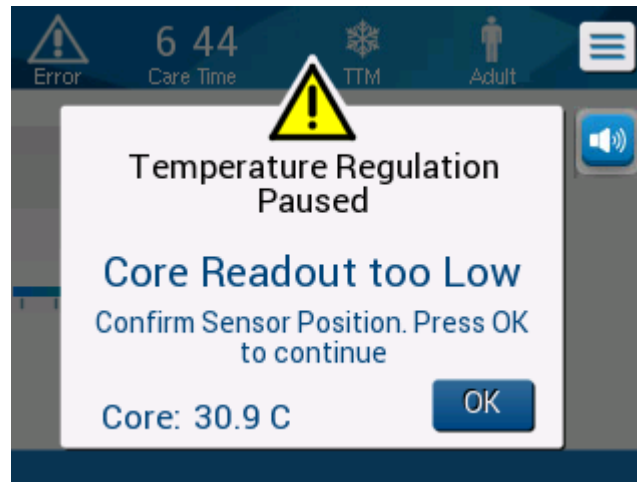

*Figure 32: Low Core Temperature Message.*

### C. Core temperature is lower than the Set Point by more than 2°C ( $\Delta (T_{sp} - T_{core}) > 2^\circ\text{C}$ ) or if $T_c < 31^\circ\text{C}$

This message could indicate that the core temperature probe might be out of place.

The following message appears: “Temperature Regulation Paused. Core Readout Too Low. Confirm Sensor Position. Press OK to continue.”



**Figure 33: Temperature Regulation Paused Message.**

An audible alarm sounds.



Touching the hard key next to the Alarm icon will mute the alarm for **five** minutes but leave the message on the screen.

**NOTE:** If the Core Temperature is below 30.5°C, the alarm cannot be silenced.

**NOTE:** If the user disregards the message and does not touch OK for over 30 minutes, the alarm cannot be silenced.

While the message appears, thermoregulation is paused and the machine switches into standby mode (water stops flowing to the wrap).

Check that the core temperature probe is in place and the low temperature represents the true patient status and then touch OK to re-activate temperature control.

When **OK** is touched, the screen returns to the main screen and the following message appears for 5 seconds.





**Figure 34: Thermoregulation is Continuing Message.**

This message indicates that water is now flowing into the wrap and that thermoregulation is continuing.

Once **OK** has been touched, the Temperature Regulation Paused message will reappear every 30 minutes that its alarm conditions are met.

While the message appears the system, status is:

**a. In Adult Mode:**

- **If Core > 31.0°C:** Thermoregulation is paused, but the machine continues to flow cold water to the wrap, so the patient does not rewarm.
- **If Core < 31.0°C:** Thermoregulation is paused, and water stops flowing to the wrap.

**b. In Neonatal Mode:**

- Thermoregulation is paused, and water stops flowing to the wrap.

Check that the core sensor is in place and the low temperature represents the true patient status and touch **OK** to re-activate temperature control.

**NOTE:** *If you disregard the message and do not touch OK for over 30 minutes, the alarm cannot be silenced.*

## Controlled Rewarming Mode Messages

During Controlled Rewarming, there may be two conditions:

**a. Virtual Set Point (VSP) Temperature - Patient Core Temp  $>0.8^{\circ}\text{C}$  and  $< 2^{\circ}\text{C}$ :**

In this case, a message appears with an alarm, but thermoregulation continues.

**b. Patient Core Temperature  $<$  Target Temperature and ( $\Delta$ Virtual SP-Core Temperature)  $>2^{\circ}\text{C}$**

This means that the core temperature probe is probably out of the body.

An audible alarm sounds, and the following message appears:



*Figure 35: Core Readout too Low Message.*

Pressing MUTE disables the audible tone. The alarm restarts after 5 minutes.

While the message “Core Readout Too Low” appears, the machine is not regulating the patient’s temperature and no water is flowing to the wrap.

Check that the core temperature probe is in place and the low temperature represents the true patient status, then touch **OK** to re-activate temperature control.

**NOTE:** If the User disregards the message and does not touch **OK** for over 30 minutes, the alarm cannot be silenced.

When **OK** is touched, the screen returns to the Main Screen and the following message appears for 5 seconds.

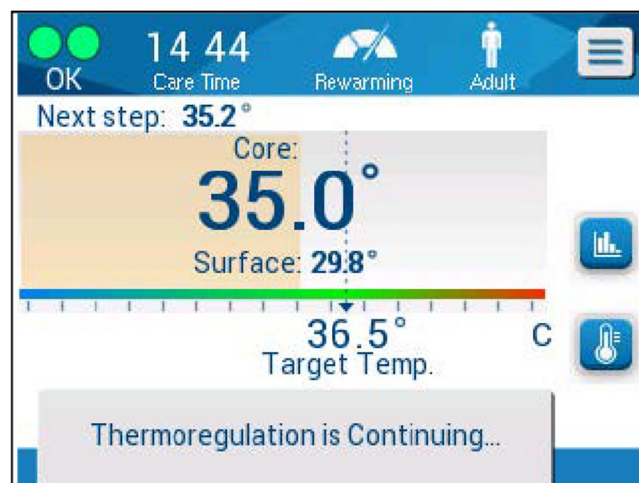

**Figure 36: Thermoregulation is Continuing Message.**

## CHAPTER 5: ORDERING INFORMATION

### *Equipment and Accessories*

All equipment and accessories may be ordered directly from your local Belmont Medical Technologies representative or your local authorized distributor. When ordering parts, specify the part number as listed in this chapter as well as the serial number of your CritiCool® system.

### Available Wraps

Models for various wraps are available. Refer to Table 10.

*Table 10: Wrap Information*

CureWrap®	Type	P/N	Number of Wraps Per Package	Patient Size/ Weight	Wrap Height / Width (m)
CureWrap® Pediatric	Infant (Single Size)	508-03518	8/Box	2.5 – 4 Kg	0.659/0.448
		508-03521	8/Box	4 – 7 Kg	0.698/0.602
	Small/Infant (Assorted)	PED-SM008	8/Box	2.5 – 4 Kg 4 – 7 Kg	0.659/0.448 0.698/0.602
			4/Box 4/Box		
	Medium (Assorted)	PED-MD008	8/Box	7 – 11 Kg 79 – 91 cm	0.981/0.628 1.118/0.740
			4/Box 4/Box		
	Large (Assorted)	PED-LA008	8/Box	91 – 104 cm 104 – 122 cm	1.225/0.841 1.390/1.054
			4/Box 4/Box		
	X-Large (Assorted)	PED-XL008	8/Box	122 – 135 cm Over 135 cm	1.582/1.1193 2.030/1.354
			4/Box 4/Box		
CureWrap® Adult	Adult (Single Size)	508-03500	8/Box	Over 135 cm	2.030/1.354

## Available Accessories

One accessory kit is provided with each system. The CritiCool Accessory Kit is available in four configurations: two with reusable temperature probes (PN# 200-00300 and PN# 200-00320) as shown in Table 11 and Table 12 and two with adapter cables for use with disposable temperature probes (PN# 200-00310 and PN# 200-00330) as shown in Table 13 and Table 14.

Disposable temperature probes need to be ordered separately. Table 15 lists common accessories that can be ordered individually.

**Table 11: CritiCool Infant Reusable Accessory Kit (PN# 200-00320)**

Sub Part No.	Description	Number Supplied
014-00005	Reusable Infant Core Temperature Probe, Gray (10FR)	1
014-00021	Reusable Surface Temperature Probe, Green	1
200-00109	Connecting Water Tubes 2 by 2 Way	1
200-R0130	Filter unit (internal)	1
DDT136009	CritiCool® Infant Step by Step Guide	1

**Table 12: CritiCool Adult Reusable Accessory Kit (PN# 200-00300)**

Sub Part No.	Description	Number Supplied
014-00020	Reusable Adult Core Temperature Probe, Gray (12FR)	1
014-00021	Reusable Surface Temperature Probe, Green	1
200-00147	Connecting Water Tubes 2 by 3 Way	1
200-R0130	Filter unit (internal)	1
DDT136011	CritiCool® Adult Step by Step Guide	1

**Table 13: CritiCool Infant Disposable Accessory Kit (PN# 200-00330)**

Sub Part No.	Description	Number Supplied
014-00028	Adapter Cable for Disposable Core Temperature Probe, Gray	1
014-00129	Adapter Cable for Disposable Surface Temperature Probe RJ, Green	1
200-00109	Connecting Water Tubes 2 by 2 Way	1
200-R0130	Filter unit (internal)	1
DDT136009	CritiCool® Infant Step by Step Guide	1

**Table 14: CritiCool Adult Disposable Accessory Kit (PN# 200-00310)**

Sub Part No.	Description	Number Supplied
014-00028	Adapter Cable for Disposable Core Temperature Probe, Gray	1
014-00129	Adapter Cable for Disposable Surface Temperature Probe RJ, Green	1
200-00147	Connecting Water Tubes 2 by 3 Way	1
200-R0130	Filter unit (internal)	1
DDT136011	CritiCool® Adult Step by Step Guide	1

**Table 15: Accessories**

Part Number	Description
014-00322	Disposable Core Temperature Probe, 20/pack
014-00321	Disposable Surface Temperature Probe RJ, 20/pack
002-00069	Male Connector for Draining Water Tank
200-R0130	Filter Unit (internal)
017-00250	CliniLogger™
200-00109	Connecting Water Tubes 2 by 2 Way
200-00147	Connecting Water Tubes 2 by 3 Way
014-00005	Reusable Core Temperature Probe Infant, Gray (10FR)
014-00020	Reusable Core Temperature Probe Adult, Gray (12FR)
014-00021	Reusable Surface Temperature Probe, Green
014-00028	Adaptor Cable for Disposable Core Temperature Probe, Gray
014-00129	Adapt Cable for Disposable Surface Temperature Probe RJ, Green

## CHAPTER 6: MAINTENANCE

### *Introduction*

This chapter outlines the maintenance instructions for the CritiCool® system. Trained hospital staff may perform routine maintenance unless otherwise specified.

***WARNING!!!*** *The repair and servicing of the CritiCool® system should be performed only by Belmont Medical Technologies or authorized agents of Belmont Medical Technologies.*

### *Service Information*

When communicating with authorized Belmont Medical Technologies representatives regarding the CritiCool® system, please provide the software version and serial numbers on the identification label located on the rear panel of the CritiCool® device (see Figure 4).

When communicating regarding wraps, refer to the label on the wrap package for lot number details.

## Routine Maintenance

The CritiCool® system should be inspected and maintained as noted in Table 16 to make sure that it remains in optimum condition.

**Table 16: Inspection and Maintenance Schedule**

Frequency	Inspection/Service	Performed By
Before each use	<ul style="list-style-type: none"> <li>• Clean connecting tubes and Quick Coupling Connector with a wet cloth.</li> <li>• Perform a visual inspection for any mechanical failure in probes, connecting tubes, and power cable.</li> <li>• Perform a visual inspection of the exterior of the CritiCool® System.</li> </ul>	Clinician or Hospital Staff
After each use / Before Storage	<ul style="list-style-type: none"> <li>• Add Sodium Dichloroisocyanurate (NaDCC) to the water tank and run for 30 minutes in Standby Mode.</li> <li>• Drain water using Empty under Services menu</li> </ul>	Clinician or Hospital Staff
As required by hospital/clinic protocol	<ul style="list-style-type: none"> <li>• Routine external cleaning and disinfecting.</li> <li>• Replace Connecting Water Hoses (PN #200-00109 and 200-00147) periodically.</li> </ul>	Clinician or Hospital Staff
Annually	<ul style="list-style-type: none"> <li>• Periodic Maintenance</li> <li>• Replace filter *</li> <li>• Thermal Disinfection application</li> </ul>	Belmont Medical Technologies authorized technician

\* Filter replacement could be performed if needed more frequently than once a year (according to water quality) if needed.



## Routine Maintenance Overview

Cleaning and disinfection of the external surface and the water reservoir of the system should be done before each use of the system. The system components may be contaminated during use and storage of the system from numerous factors.

### CAUTION!

- Do not use any kind of brush on the machine touch screen or its accessories.
- Do not submerge the machine in liquid.
- Do not wash the electrical power socket.
- Do not use any saline or irrigated fluids.
- Do not use any ester solvents.
- Always check the temperature probes for scratches and tears before and after cleaning. If the probe is damaged, do NOT use it.

For reusable temperature probes, follow the manufacturer's recommendations and always check the temperature probes for scratches and tears before and after cleaning. If the probe is damaged, do NOT use it.

*NOTE: Follow your hospital protocols for disinfecting the product.*

## Required Tools for Cleaning and Disinfection

- PPE (Personal Protective Equipment) according to the disinfectant manufacturer's instructions.
- Lint Free Cloths
- Sodium Dichloroisocyanurate (NaDCC) powder or tablets
- Sterile water / 0.22 micron filtered tap water (approximately 6 liters)

## Recommended Disinfectants for External Surfaces

- Chlorinated bleach solution (5.25% sodium hypochlorite concentration)
- Quaternary ammonium compounds (ammonium chloride as active ingredient)

## Before Each Use

**CAUTION!** Apply finger pressure only. External instruments exert excessive pressure on the screen and should not be used.

1. Use PPE as recommended by the disinfectant's manufacturer.
2. Make sure that the system is turned off and unplugged from power.
3. Using a lint free cloth with sterile water, clean the exterior of the machine and the LCD screen from any soiling.

4. Prepare the disinfectant solution as described by the manufacturer and follow the manufacturer's directions for time duration and concentration.
5. Using a lint free cloth with the disinfectant, disinfect the exterior of the machine, the LCD screen, and the hoses.
6. For residue removal, use a new lint free cloth moistened with sterile water. Use the cloth on the exterior of the system, the screen, and the hoses.

## **Before Storage**

1. Use PPE as recommended by the disinfectant's manufacturer.
2. With the system in Standby Mode, disconnect the temperature probes from the patient.
3. Dispose of disposable temperature probes in accordance with hospital procedures for medical waste. Disinfect reusable temperature probes or adapter cables as required by the manufacturer's directions.
4. Close the clamps on the wrap.
5. Remove the wrap from the patient; disconnect it from the hoses and dispose of it.
6. Disconnect the hoses from the machine and then wipe with alcohol.
7. Insert the volume of Sodium Dichloroisocyanurate (NaDCC) powder or tablets as recommended by NaDCC manufacturer into 6-liter water tank.
8. Run the system in Standby Mode for 30 minutes.
9. Empty the device. (See Figure 20).
10. Turn off the machine. Unplug the power cord.

## ***Cleaning, Disinfecting and Sterilization of the Reusable Temperature Probes***

The cleaning, disinfection and sterilization of the reusable temperature probes are according to the manufacturer's instruction.

Disposable probes are not to be reused. Improper use can lead to cross contamination and deterioration of safety.

## Thermal Disinfection (Self-Cleaning)

This feature performs a thermal disinfection of the water tank and internal tubing.

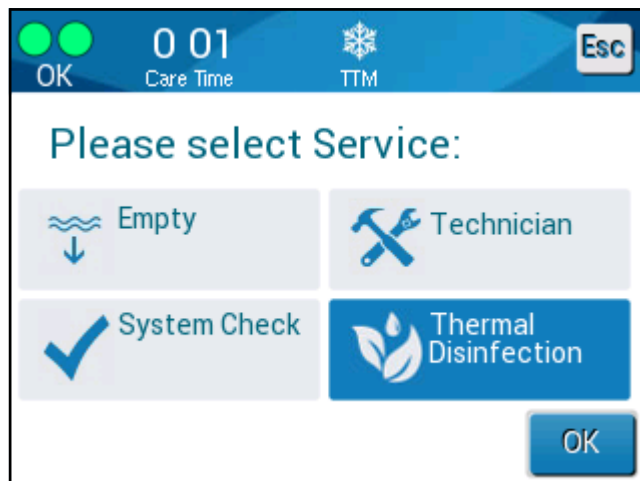

The thermal disinfection of CritiCool® is an integrated feature, which heats the circulating water of the system, thus allowing the heat to disinfect the internal water pathways of the system, including the water tank.

Thermal disinfection is performed at every periodic maintenance and can only be performed by a Belmont certified technician. Refer to the Service Manual for more information.

## System Check Service

The System Check service is initiated from the Services menu.

The System Check service performs a complete check of the system by checking the functionality of the following components:

- Screen and buzzer
- Pump
- Wrap connection
- Pressure meter
- Heating and Cooling unit
- Temperature of water inflow and water outflow

Successful completion of the system check service indicates that the CritiCool® system is operational.

**NOTE:** *If the CritiCool® was out of use for a long time, a full System Check should be performed.*

**To perform system check:**

**NOTE:** Before performing System Check, verify that the water tank is full.

1. In the main menu, select **Services**. The following window appears:



**Figure 37: Selecting System Check.**

2. In the **Services** screen, select **System Check** then click **OK** to confirm. A message appears requesting you to confirm start of System Check.

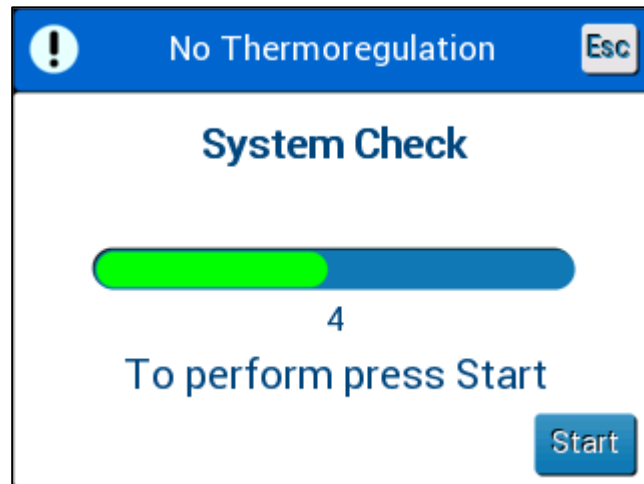

**Figure 38: System Check in Progress.**

3. Touch **Start**.  
System Check is initiated. The progress bar that appears on the screen indicates the progress.  
System Check takes about 10 minutes.  
When the process is completed, a message appears on the screen "SYSTEM CHECK COMPLETED".
4. Switch to the Operation screen.
5. Turn CritiCool® off.

## Filter Replacement

The filter is for filtering hard soils or large particles. It is not intended for filtering the water from bacterial contamination.

The filter must be replaced every twelve months at a minimum.



**NOTE:** *The filter should be replaced only by Belmont Medical Technologies authorized personnel. See the Service Manual for replacement instructions.*

## CHAPTER 7: TROUBLESHOOTING

### *General*

The CritiCool® system is equipped with self-testing routines that continuously monitor system operation. If a system fault or malfunction is detected, a fault message appears. Should a malfunction occur, consult the Troubleshooting Guide.

### *Troubleshooting Guide*

Table 17 lists some possible scenarios that may indicate a malfunction, their cause, and recommended actions.

Table 18 lists water tank overfilling troubleshooting.

Table 19 through Table 23 provides a list of fault messages that appear on the CritiCool® system screen.

**WARNING!!!** The repair and servicing of the CritiCool® system should be performed only by Belmont Medical Technologies or authorized agents of Belmont Medical Technologies.

**Table 17: CritiCool® System Malfunction (no message) Troubleshooting Guide**

Observation	Possible Problem	Action to be Taken
The power switch of the CritiCool® system is set to "ON" but it is not activated, and the control panel is blank.	CritiCool® system is unplugged.	Check the 100, 115/230 VAC power cable connections.
	No line voltage	Call Biomedical Department.
Wrap begins to leak.	The wrap was accidentally punctured during operation.	Turn off the CritiCool® system and allow the water to return to the reservoir. Replace the Wrap if possible.
Water leaks from the connector between Wrap and the connecting tube.	Connecting tubes are not sealed properly.	Close clamps on Wrap. Disconnect connecting tubes and re-connect connecting tubes until the click sound is heard.
	Damage to connecting tubes.	Replace connecting tubes.
	Damage to quick coupling connector.	Call Biomedical Department.
Water leaks between connecting tubes and the CritiCool® device.	Connecting tubes are not connected properly.	Disconnect connecting tubes from the machine and re-connect again until the click sound is heard.
	Damage to connecting tubes.	Replace connecting tubes.
	Damage to Quick coupling connector.	Call Biomedical Department.

**NOTE:** A muted alarm is activated when a subsequent message appears.

Table 18: Water Tank Overfilling

Observation	Action to be taken
Water tank overfilled.	<p>It is necessary to drain the water tank after each use:</p> <ol style="list-style-type: none"> <li>1 Connect one connecting tube to the right quick coupling connector.</li> <li>2 Connect the special male connector to the water-out connecting tube (the gray end if using the 2x3 Way Connecting Water Hoses).</li> <li>3 Turn the CritiCool® device ON.</li> <li>4 Select <b>Empty</b> mode in <b>Services</b>.</li> <li>5 Prepare to allow the excess water to drain into a receptacle, pail or sink.</li> <li>6 Water should begin once Start has been pressed. If it does not, exit from Empty mode, disconnect the special male connector from the current connecting tube, connect it to the other connecting tube instead, then begin.</li> <li>7 A message will appear when the water tank is empty, at which point CritiCool® system can be powered down.</li> </ol> 



Table 19: CritiCool® System Messages Troubleshooting Guide



Message	Cause of Problem	Action to be taken	Comments
 Indicates that an alarm is activated			
Tank is Empty 	No water in the tank.  Water tank float is jammed.	Open water tank cap. Refill water tank to maximum level.  Insert a long object to release the float.	
Add Water 	Water level is too low.	Refill water tank to maximum.	The alarm can be muted for an unlimited time.
Connect Water Tubes 	Connecting tubes are not connected.	Connect connecting tubes, listening for the click. Check for creases, folds, or objects that obstruct the water flow in the wrap.  Check clamps.	* Pressing alarm mute silences the buzzer for 30 minutes.

Table 20: CritiCool® System Messages Troubleshooting Guide

Message	Cause of Problem	Action to be taken	Comments
<p>Connect Core Temperature Probe</p> 	<p>No core temperature probe is inserted in its socket.</p>	<p>Connect core temperature probe.</p>	<p>* Pressing alarm mute silences the buzzer for 30 minutes.</p>
<p>Check Water Tubes</p> 	<p>Wrap is blocked due to improper wrapping.</p> <p>Wrap clamps are closed.</p>	<p>Check for creases, folds, or objects that obstruct the water flow in the wrap.</p> <p>Check clamps.</p>	<p>* Pressing alarm mute silences the buzzer for 30 minutes.</p>
<p>Check Core Temperature Probe</p> 	<p>Misplacement of core temperature probe in core socket.</p> <p>Core temperature probe's adapter is connected to the CritiCool® without the temperature probe.</p>	<p>Connect the core temperature probe to the appropriate socket.</p> <p>Connect disposable temperature probe to the adapter cable and insert into the patient.</p>	<p>This alarm cannot be muted.</p>

Table 21: CritiCool® System Messages Troubleshooting Guide

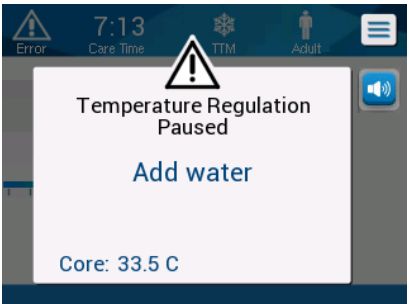
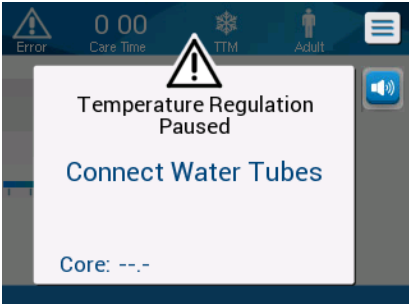

Message	Cause of Problem	Action to be taken	Comments
<p>Core Readout Too Low</p> 	<p>Core temperature is at least 2°C lower than Set Point – or the core temperature is below 31°C.</p>	<p>Confirm the location of the core temperature probe. Press OK to continue.</p>	<p>An alarm issues and thermoregulation stops. The alarm can be muted for 5 minutes. NOTE: If you disregard the message and do not touch OK for over 30 minutes, the alarm cannot be silenced until the OK button is touched. When OK is touched, the screen returns to the Main Screen and a message appears for 5 seconds indicating that thermoregulation has resumed.</p>
<p>Switching to AutoRewarm Mode</p> 	<p>Confirmation of the patient's core temperature before changing to Controlled Rewarming mode.</p>	<p>Confirm the patient's temperature. Once confirmed, press OK to continue.</p>	<p>This alarm cannot be muted.</p>
<p>Water Temperature Too Low</p> 	<p>Water temperature in the system is less than 10°C (50°F).</p>	<p>Thermoregulation stops. Turn OFF the system for 3 seconds and then turn it ON again. If the problem persists, turn OFF CritiCool® and contact a Belmont Medical Technologies representative.</p>	<p>The alarm can be muted for unlimited time.</p>

Table 22: CritiCool® System Messages Troubleshooting Guide

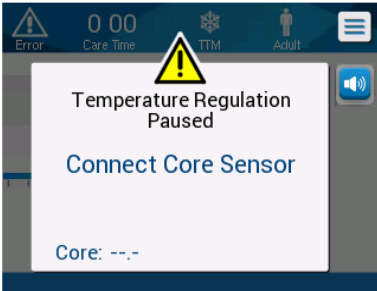
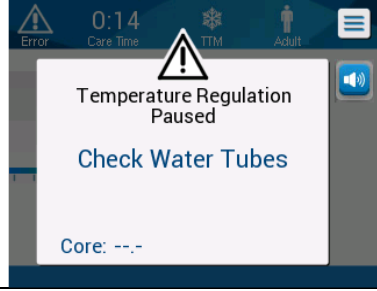
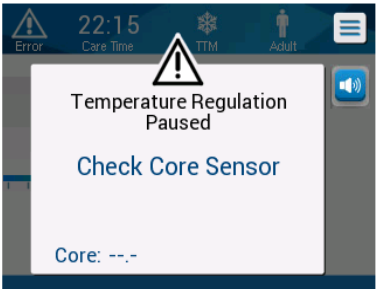

Message	Cause of Problem	Action to be taken	Comments
<p>Water Temperature Too High</p> 	<p>Water temperature in the system is more than 42°C (107.6°F).</p>	<p>Thermoregulation stops until the water cools or the system halts. Turn OFF the system for 3 seconds and then turn it ON again. If the problem persists, turn OFF CritiCool® and contact a Belmont Medical Technologies representative.</p>	<p>The alarm can be muted for an unlimited time.</p>
<p>Patient's temperature is above XX.X°C</p> 	<p>The alarm for High Patient Temperature can be configured in "Settings". The alarm and message are issued according to the selected alarm limit. The available values are: 36°C, 36.5°C, 37°C, 37.5°C, 38°C, and 38.5°C.</p>	<p>Check that the core temperature probe is in place and follow the patient's temperature.</p> <p>Inform the clinician.</p>	<p>Thermoregulation continues.</p> <p>The alarm can be muted for 30 minutes.</p>
<p>Low Core Temperature Thermoregulation is continuing.</p> 	<p>This message appears:</p> <ol style="list-style-type: none"> <li>When core temperature is below the Set Point by 0.8°C but less than 2.0°C</li> <li>According to alarm settings.</li> </ol>	<p>Check core temperature probe is in place and keep following the patient's temperature. No action is required. If rewarming manually: Do not attempt to increase more than 0.8°C above actual core temperature.</p>	<p>An alarm issues but thermoregulation continues.</p> <p>The message on the screen will disappear once the patient reaches within 0.6°C of set point.</p> <p>The alarm can be muted for 30 minutes.</p>

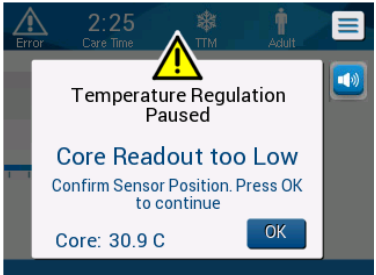
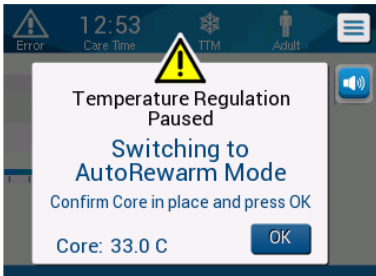
Table 23: CritiCool® System Messages Troubleshooting Guide

Message	Cause of Problem	Action to be taken	Comments
<p>Patient's temperature is below XX.X°C</p> 	<p>Core temperature is below the alarm limit preconfigured in the Settings panel. The alarm and message are issued according to the selected alarm limit. The available values are: 31°C, 32°C, 33°C, 34°C, 35°C, and 36°C.</p>	<p>Check that the core temperature probe is in place and follow the patient's temperature. Inform the clinician.</p>	<p>Thermoregulation continues.</p> <p>The alarm can be muted for 30 minutes</p>
<p>Body temperature in accepted range</p> 	<p>Core temperature has reached set point.</p>		<p>The message appears for 5 seconds.</p>
<p>Thermoregulation is Continuing.</p> 	<p>CritiCool has left an alarm state and returned to a normal operation mode.</p>	<p>Confirm patient's temperature.</p>	<p>The message appears for 5 seconds.</p>

<p>Out of Normothermia Range</p> 	<p>User has selected a Set Point Temperature beyond the normothermia range of &gt;32°C and &lt;38.0°C.</p>	<p>Touch OK to confirm the new Set Point temperature and eliminate the message.</p>	<p>Thermoregulation continues.</p>
--	--	---	------------------------------------

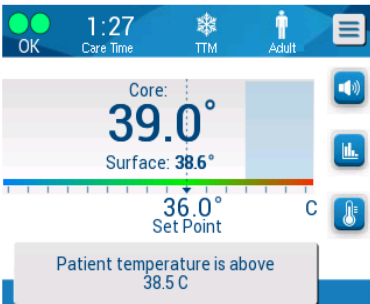
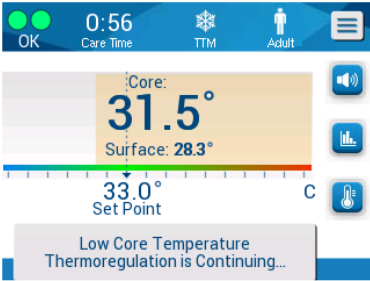
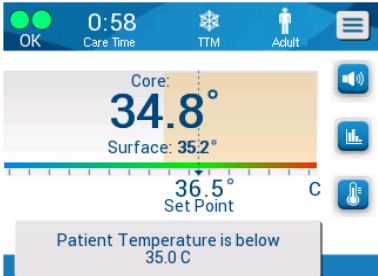
# CHAPTER 8: CLINILOGGER™ INSTALLATION AND OPERATING INSTRUCTIONS

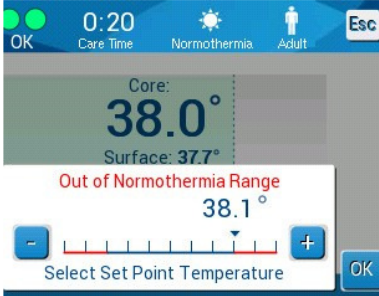
## *Overview and Installation*

### Introduction

The purpose of the optional CliniLogger™ device is to save the CritiCool® / CritiCool® MINI / Allon® systems' vital data for further reference. For more information on connecting the CliniLogger to CritiCool for data collection, see CliniLogger™ Technical Specifications on page 31.

By means of the CliniLogger™ Viewer software, the user can use an external PC to review this saved data.

### Using the CliniLogger™ Application

The CliniLogger™ device connects to the RS-232 (serial) connector in the rear of the CritiCool® for data transfer. While the device is connected **data is saved at each one-minute interval.**

Connect the CliniLogger™ device to the CritiCool® before the start of the medical procedure.

Belmont Medical Technologies recommends recording CritiCool® device data for one patient at a time. At the end of the procedure, disconnect the CliniLogger™ device from the thermoregulation machine and connect to a PC. Download the data from the device and then reconnect the CliniLogger™ to the thermoregulation machine so it is ready for the next procedure.

### The CliniLogger™ Software

The CliniLogger™ device is supplied with a CliniLogger™ Viewer software CD to be installed on a PC for downloading and viewing the saved data from the CritiCool®. Alternatively, to download the software online, request the link from the Belmont technical service team at [techservice@belmontmedtech.com](mailto:techservice@belmontmedtech.com).

### Installing the Software

#### *To install the CliniLogger™ software:*

1. On your PC, double-click on **My Computer** and open the CD drive.
2. Double-click the **Installer** folder.
3. Double-click the **Volume** folder
4. Double-click **setup**; the CliniLogger™ install window appears.

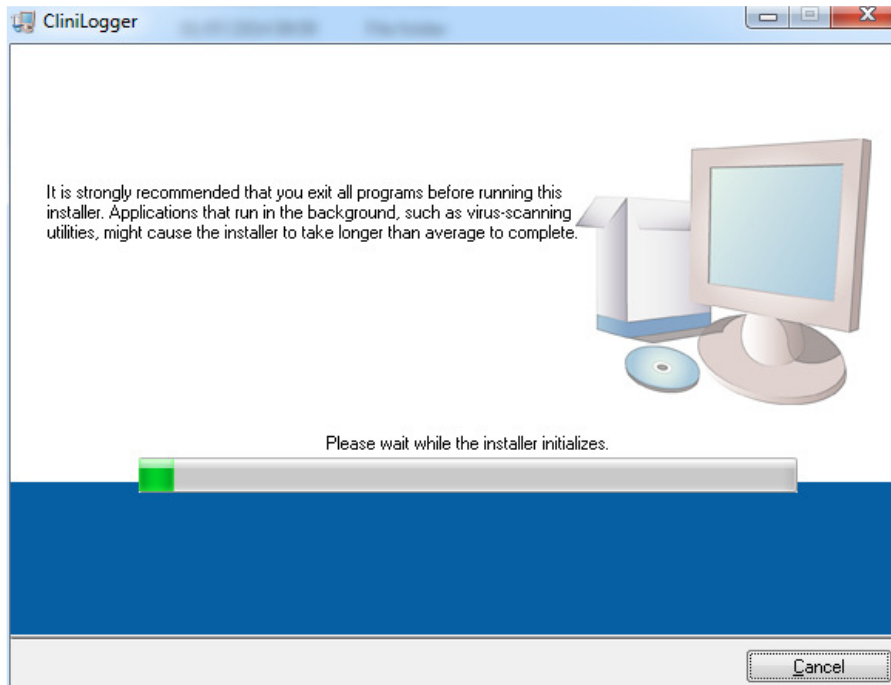

**Figure 39: CliniLogger™ Initialization.**

When initialization finishes the following screen appears.

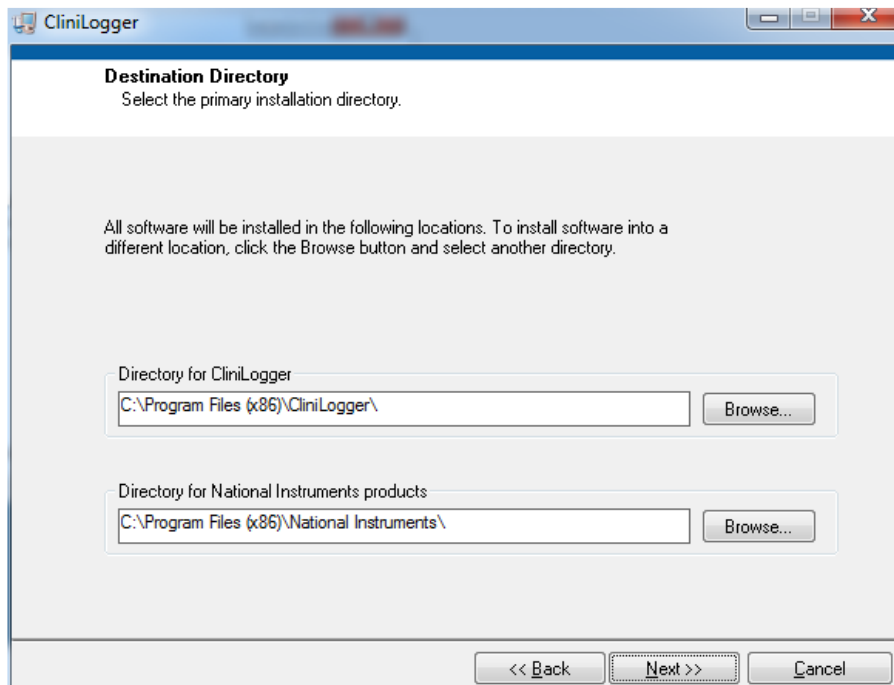
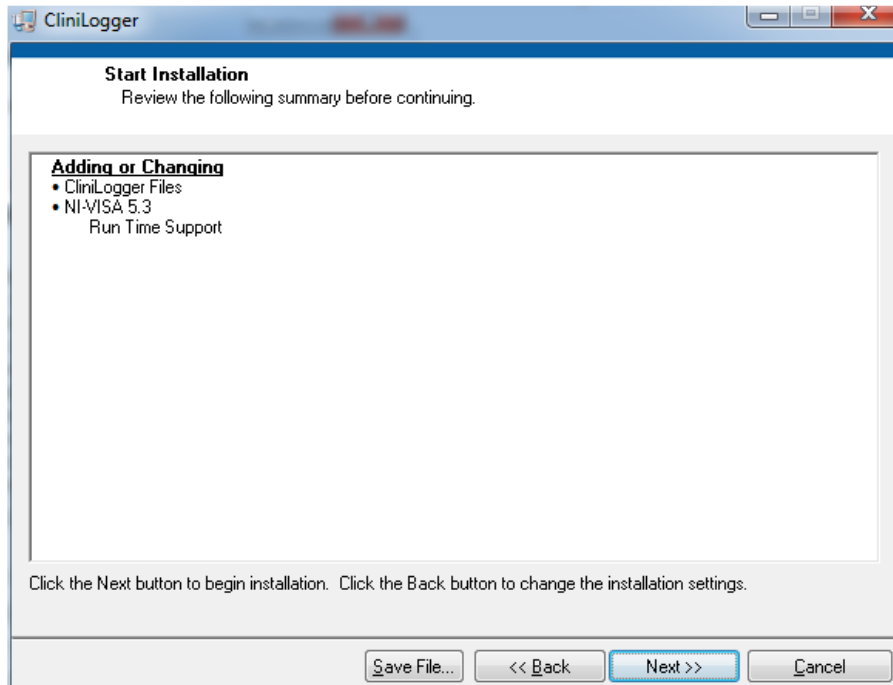

**Figure 40: CliniLogger™ Installation.**

5. You can change the installation location by clicking **Browse** and selecting a new location. Click **Next**. **The License Agreement window appears.**



6. Select **I accept the above License Agreement(s)** to accept the license agreements and click **Next**. The Start Installation window appears.



**Figure 41: Start Installation.**

7. Click **Next**; you can follow the installation progress in the progress bars until it finishes.

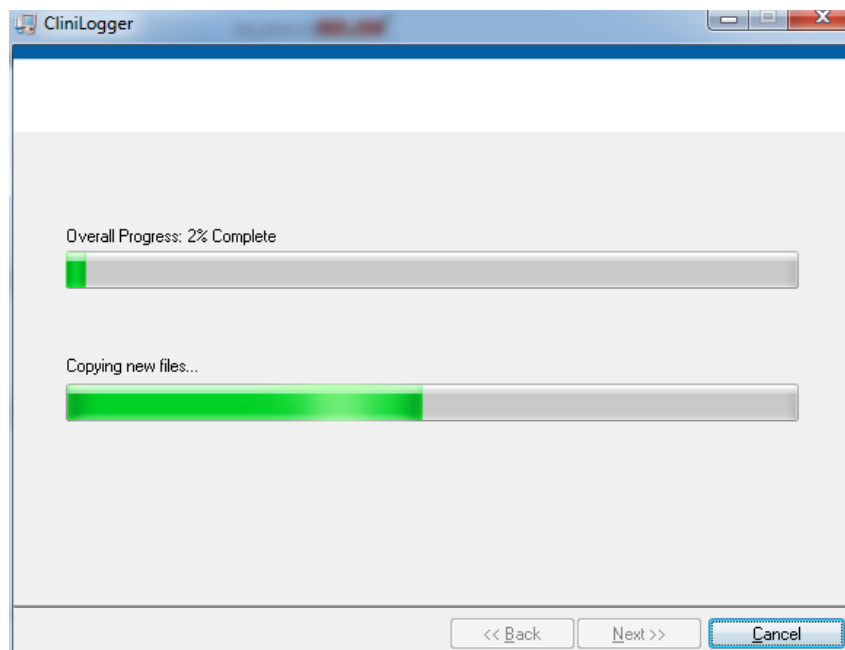

**Figure 42: Installation Progress.**

When the installation is finished, the **Installation Complete** window appears:

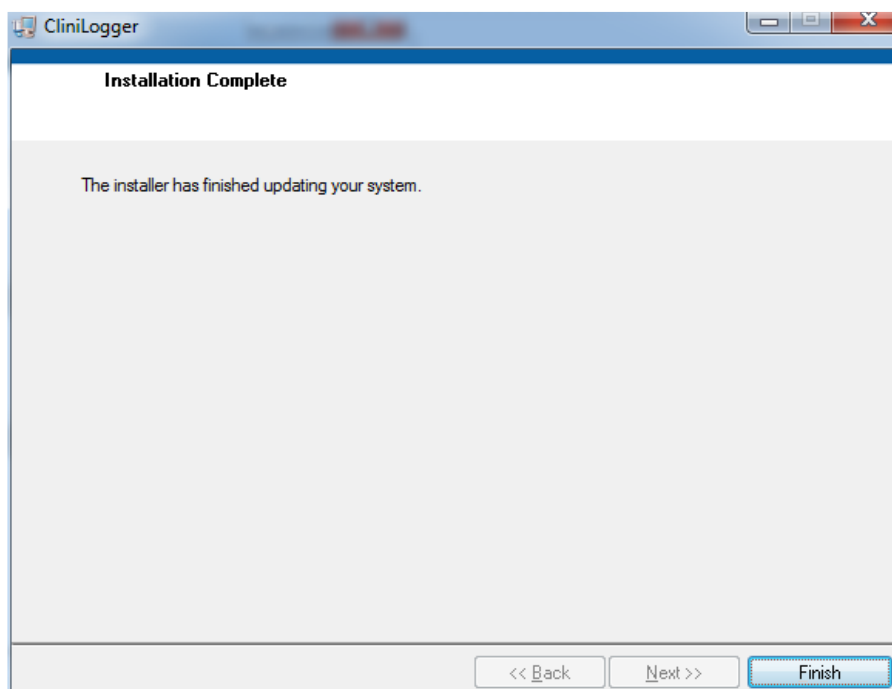

**Figure 43: Installation Complete.**

8. Click **Finish** to complete and exit the software installation.
9. Copy "User Ver 1.6" folder from CD to your desktop.
10. You can now open "User Ver XX." folder and click the CliniLogger.exe file to start the application.

## Using the CliniLogger™ Viewer Application

### Downloading Data

You can download data from the CliniLogger™ Device to the CliniLogger™ Viewer Application on the PC.

#### To start the CliniLogger™ application:

1. From the Windows **Start** menu, click **Programs** > **CliniLogger**.
2. Click on the **CliniLogger™** icon; the CliniLogger™ window appears.

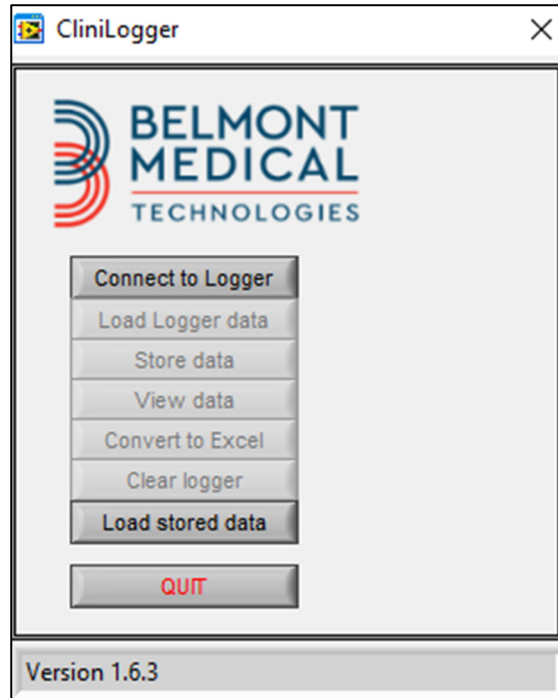

Figure 44: CliniLogger™ Application Window.

3. Connect the CliniLogger™ device to the serial COM1 port of the PC.

**NOTE:** Verify that the CliniLogger™ device is connected to the COM 1 –10 port or you can use with USB to RS232 adaptor.

4. Click **Connect to Logger**, the software traces the COM port where the CliniLogger™ is connected – wait for the **Connected** message.

5. Click **Load Logger data**, wait for the **Complete** message.
6. Click **Store data** and choose a file and a location.
7. Click **View data**; the graph opens.
8. You can also click **Convert to Excel** to present the data in Excel format.
9. Click **Clear logger** after saving the data to prepare the device for the next use.

**IMPORTANT!** You should erase the data on the CliniLogger™ manually after each patient. Otherwise, the CliniLogger™ continues to burn data from the earliest patient.

## Viewing Downloaded Data

**To view downloaded data:**

1. Double-click the CliniLogger™ Viewer icon. The CliniLogger™ window appears.

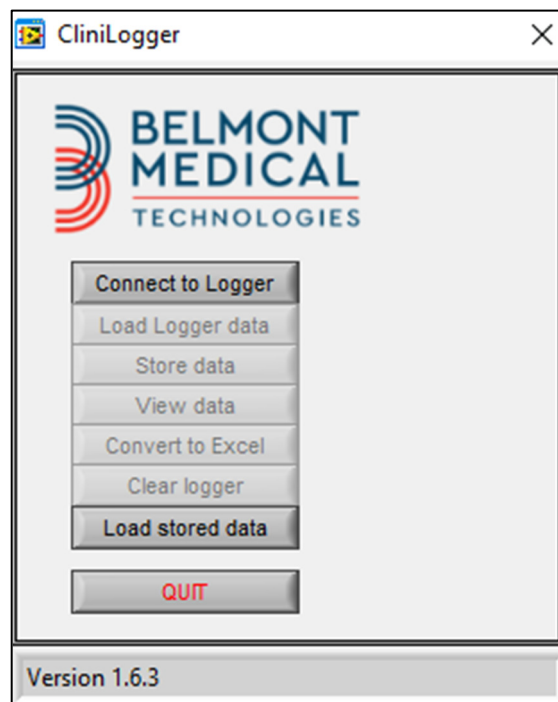

**Figure 45: CliniLogger™ Window.**

2. Click Load stored data and choose the file you would like to view.

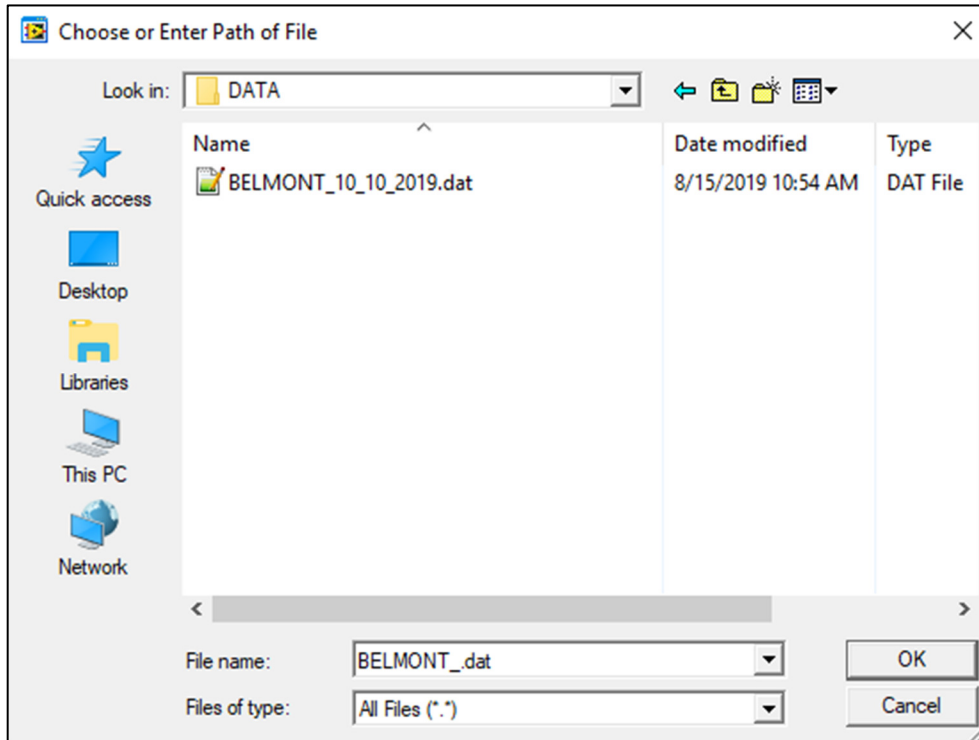

Figure 46: Choose CliniLogger™ File Window.

When the data has been loaded the “Complete” message appears

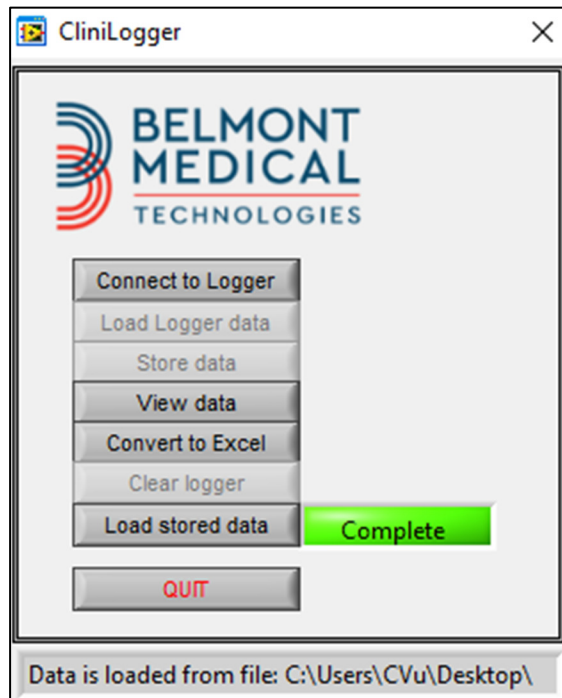

Figure 47: Complete Message.

3. Click **View data** - the graph opens.
4. To convert to Excel, click **Convert to Excel** – the data is presented in Excel format.

## CliniLogger™ Viewing Panel



Figure 48: CliniLogger™ Viewing Panel.

The CliniLogger™ viewing panel includes the following data:

- **Start date and time** received from the thermoregulation device (Criticool®)
- **Software version** of the thermoregulation device
- **Close Window** button
- Function Selection area: control keys
- Graphic Display area with a graphic presentation of the thermoregulation system variables.

## Graphic Display Area

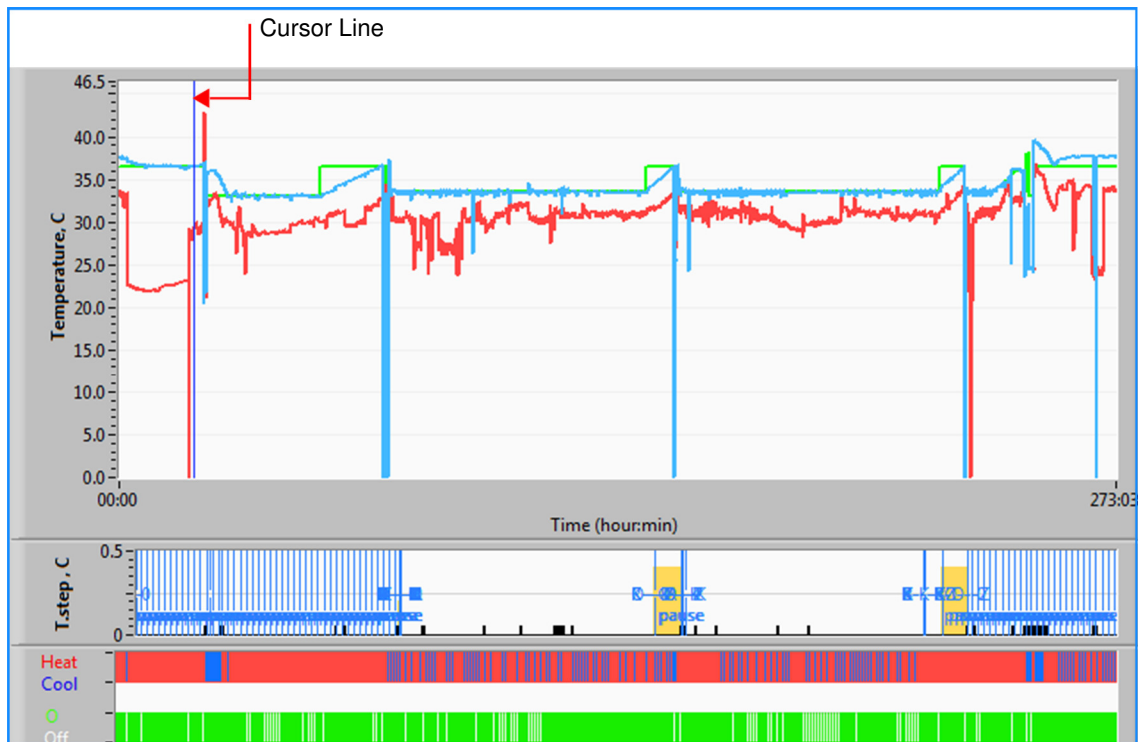
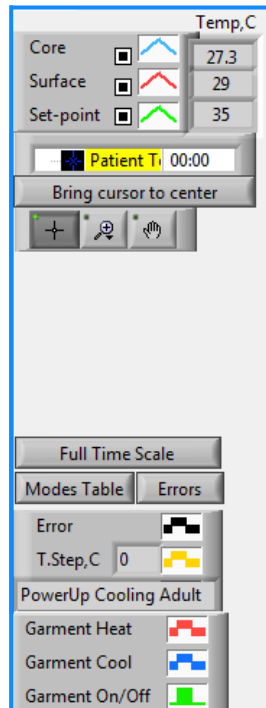

Figure 49: Graphic Display Area.

The Graphic Display area consists of three parts:

- **Temperatures graphs:** Set-point, Core and Surface as a function of time
- **Modes and Error area:** Thermoregulation modes, Rewarming step and errors as a function of time
- **Device Functional Status area:** Heat/Cool and Pump On/Off

## Function Selection Area

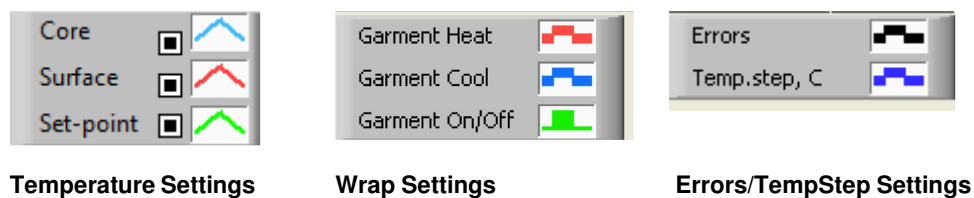

**Figure 50: Example: Functional Status Area.**

The Function Selection area includes the keys that provide the ability to modify the Graphic Display area, such as zooming in and out, moving between time zones and detailing the viewed data.

## Temperature Graph Control Buttons

These buttons define the shape of the curves in the temperature graphs area, the water heat/cool graph and the water flow graph.



**Figure 51: Example: Modes and Errors Area.**

Temperature graph control buttons enable modifying the display of each of the temperature graphs.



## Display / Hide Buttons

Use the temperature setting toggle buttons to Display / Hide each of the temperature graphs.

## Color Buttons

These buttons allow for changing the graph features and colors.

**NOTE:** It is recommended to keep the default settings.

## View Manipulation Buttons

A set of three buttons is shown under the temperature buttons



**Hand** - Click the Hand  button, using the mouse move the hand cursor to the temperature graph area; and “grab” the curve by pressing the mouse left button and moving the mouse.

Moving the mouse horizontally will move the graphs horizontally - in time, and moving the mouse vertically, will move the graphs vertically - in temperature.

**Zoom** Clicking the Zoom button shows 6 modes of zoom use:

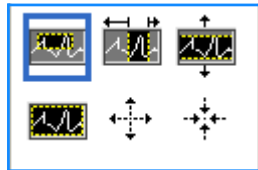







Table 24: Zoom Tool Buttons

Button	Click to...	How to use...
	return the graphs to the default (un-zoomed) display	
	zoom out symmetrically in X and Y directions	Click this zoom tool button. Using the mouse move the cursor to the Temperature graph; the cursor image changes to the button icon. Click the mouse to zoom out. You can click again to zoom out again.
	zoom in symmetrically in X and Y directions	Click this zoom tool button. Using the mouse move the cursor to the Temperature graph; the cursor image changes to the button icon. Click the mouse to zoom in. You can click again to zoom in again.
	create an XY zoom in box.	Click this zoom tool button. Using the mouse move the cursor to the Temperature graph; the cursor image changes to zoom icon. Press the left mouse button and select the box in the graph for zooming in. Once you release the mouse button the image is zoomed in.
	zoom in, in the X (Time) direction.	Click this zoom tool button, using the mouse move the Zoom tool cursor to the required point of time, click to insert the low limit line, keep the left key pressed and pull horizontally to the end of the time period desired. Once you release the mouse button the image is zoomed in.
	zoom in, in the Y (Temperature) direction.	Use the mouse move the Zoom tool cursor to the lower temperature limit, click to insert the low limit line, keep the left key pressed and pull vertically. Release the key to view the temperature graphs zoomed in the selected vertical area.

**To return to full time scale after zoom actions:**

1. Click on .

The graph returns to the full-time range, without affecting the Temperature scale.

**NOTE:** To return to the original display click the unzoom button .

## Cursor Line

The values of the temperatures at the cursor line location appear in the window adjacent to the curve color window (see Figure 48).

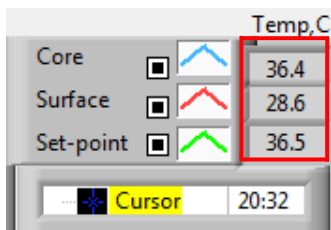



You can change the time of the Cursor Line on the graph (see Figure 48).

### To set the time of the cursor:

1. Use the keyboard to set the required time in the **Cursor** textbox. Make sure to select the time as displayed on the graph (and in the HH:MM format).
2. Press ENTER.

The cursor moves to the selected time spot and the Temperatures displayed are the temperatures of the new spot.

### To move the cursor line, in time (X direction)

1. Click the Cursor  icon.
2. Bring the + to the cursor location, the + will convert to a double line 
3. Use the mouse to move the double line to a new cursor location.

**NOTE:** The values of the temperature at the cursor location appear in the window adjacent to the curve color window

## Modes and Error Area

This area provides the following information:

**System mode** marked by letters (See Figure 52) and a vertical line.

**Rewarming** steps between 0°C and 0.5°C shown in the example in pink (the step was first 0.4°C and then changed to 0.2°C).

**Error:** Period with no control, in the example due to system pause (yellow markings).

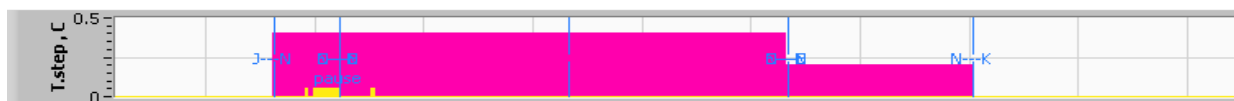

Figure 52: Example of Modes and Error Area.

Table 25: Mode Codes

Code	Indicates		
<b>A</b>	PowerUp	Cooling	Adult
<b>B</b>	PowerUp	Cooling	Neonate
<b>C</b>	PowerUp	Warming	Adult
<b>D</b>	PowerUp	Warming	Neonate
<b>E</b>	PowerUp	Rewarm	Adult
<b>F</b>	PowerUp	Rewarm	Neonate
<b>G</b>	PowerUp	Standby	
<b>H</b>	PowerUp	Sel.Mode	Adult
<b>I</b>	PowerUp	Sel.Mode	Neonate
<b>J</b>	Cooling	Adult	
<b>K</b>	Cooling	Neonate	
<b>L</b>	Warming	Adult	
<b>M</b>	Warming	Neonate	
<b>N</b>	Rewarming	Adult	
<b>O</b>	Rewarming	Neonate	
<b>P</b>	Standby		
<b>Q</b>	Select Mode		Adult
<b>R</b>	Select Mode		Neonate

## Functional Status Area – Heat/Cool and Pump On/ Power Off

The graphs indicate the state of the wrap: **Heat / Cool** modes and the **On/Off** of **water circulation** in the wrap.

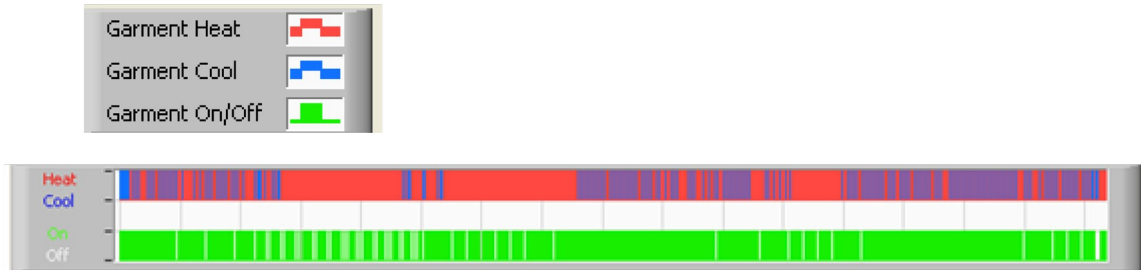

**Heat/Cool-** When CritiCool® is cooling the water in the tank, the line is blue. When the device is warming the water in the tank, the line is red.

**Pump On/Off-** When the pump is pumping water into the Wrap, the line is green. When CritiCool® is circulating the water internally (i.e. in "Standby mode"), the line is white.

## Converting to Excel

*To convert to Excel:*

1. On the CliniLogger™ menu panel (see in Figure 8-6) select **Convert to Excel**; an Excel file opens with two options:

### Measurement Table (Sheet 1)

	A	B	C	D	E	F	G	H
1	Date&Time	Record Time	Core	Surface	Set-Point	Mode	Errors	
2	2018/ 6/11 1:50:34	0: 0	33.2	29.7	33.5 K			
3	2018/ 6/11 1:51:34	0: 1	33.3	29.9	33.5 K			
4	2018/ 6/11 1:52:34	0: 2	33.3	30.2	33.5 K			
5	2018/ 6/11 1:53:34	0: 3	33.2	30.3	33.5 K			
6	2018/ 6/11 1:54:34	0: 4	33.3	30.6	33.5 K			
7	2018/ 6/11 1:55:34	0: 5	33.3	30.7	33.5 K			
8	2018/ 6/11 1:56:34	0: 6	33.3	30.8	33.5 K			
9	2018/ 6/11 1:57:34	0: 7	33.4	30.8	33.5 K			
10	2018/ 6/11 1:58:34	0: 8	33.4	33.8	33.5 K			
11	2018/ 6/11 1:59:34	0: 9	33.4	34.2	33.5 K			
12	2018/ 6/11 2: 0:34	0:10	33.4	34.5	33.5 K			
13	2018/ 6/11 2: 1:34	0:11	33.4	28.5	33.5 K			
14	2018/ 6/11 2: 2:34	0:12	33.5	27	33.5 K			
15	2018/ 6/11 2: 3:34	0:13	33.5	27	33.5 K			
16	2018/ 6/11 2: 4:34	0:14	33.5	27.7	33.5 K			
17	2018/ 6/11 2: 5:34	0:15	33.5	27.1	33.5 K			
18	2018/ 6/11 2: 6:34	0:16	33.5	27.6	33.5 K			
19	2018/ 6/11 2: 7:34	0:17	33.6	30.2	33.5 K			

Figure 53: Section of Excel Table.

## Graphic Chart

A second page in the Excel file shows a graphic description of the Excel table with the Y axis showing the temperatures, and the X axis the Excel table lines.

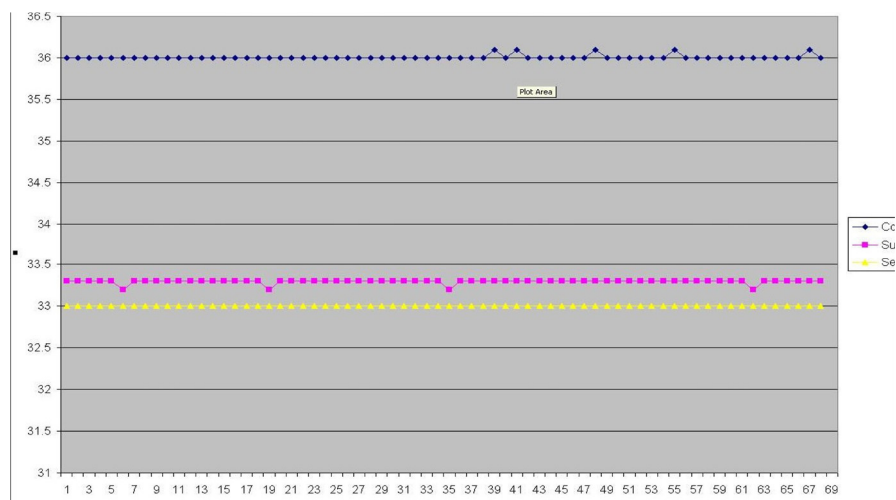

**Figure 54: Section of Graphic Chart.**

## Ending a Viewing Session

### ***To end a session:***

Click **Quit** on the Main Menu to exit the Viewing Session

# APPENDIX A:

## Belmont Medical Technologies CUSTOMER SERVICE REPRESENTATIVE

**WARNING!!!** *The following details are necessary to contact your Belmont Medical Technologies representative. Keep this form with the User Manual for scheduling annual periodic maintenance and/or servicing needs.*

Representative Name:	
Company Name:	
Address:	
Telephone No:	
Fax:	
E-mail:	

CritiCool® Passcode for the Settings Screen:

# APPENDIX B: RF SEPARATION

The CritiCool® plus CliniLogger™ are intended for use in an electromagnetic environment in which radiated RF disturbances are controlled. The customer or the user of the CritiCool® plus CliniLogger™ can help prevent electromagnetic interference by maintaining a minimum distance between portable and mobile RF communications equipment (transmitters) and the CritiCool® plus CliniLogger™ as recommended below, according to the maximum output power of the communications equipment.

Recommended separation distances between portable and mobile RF communications equipment and the CritiCool® plus CliniLogger™ are given in Separation Distances in meters.

**Table 26: Separation Distances in meters**

Rated maximum output power of transmitter W	Separation distance according to frequency of transmitter (m)		
	150 kHz to 80 MHz $d = \left[ \frac{3,5}{E_1} \right] \sqrt{P}$	80 MHz to 800 MHz $d = \left[ \frac{3,5}{V_1} \right] \sqrt{P}$	800 MHz to 2,5 GHz $d = \left[ \frac{7}{E_1} \right] \sqrt{P}$
0.0 1	0.12	0.12	0.23
0.1	0.38	0.38	0.73
1	1.2	1.2	2.3
10	3.8	3.8	7.3
100	12	12	23

For transmitters rated at a maximum output power not listed in the table, the recommended separation distance **d** in meters (m) can be estimated using the equation applicable to the frequency of the transmitter, where P is the maximum output power rating of the transmitter in watts (W) according to the transmitter manufacturer.

**NOTE:** At 80 MHz and 800 MHz, the separation distance for the higher frequency range applies.

**NOTE:** These guidelines may not apply in all situations. Electromagnetic propagation is affected by absorption and reflection from structures, objects and people.



# **APPENDIX C: WASTE ELECTRICAL & ELECTRONIC EQUIPMENT (WEEE)**

The crossed-out wheel bin symbol on the product, literature, or packaging reminds you that all electrical and electronic products, batteries, and accumulators must be taken to separate collection at the end of their working life. This requirement applies to the European Union and other locations where separate collection systems are available. To prevent possible harm to the environment or human health from uncontrolled waste disposal, please do not dispose of these products as unsorted municipal waste, but instead, hand in at an official collection point for recycling.